

SAFETY AND PROPER USAGE

To ensure safe and enduring performance of this product, you must comply strictly with the instructions enclosed herein. Non-compliance with instructions or improper handling of the product will void your warranty! Usage of this product in conditions not specified in this manual or in contrary to the instructions hereby provided is considered IMPROPER. The manufacturer will not be held liable for any damages resulting from improper use of the product.

SAFETY & WARNING INSTRUCTIONS

- Observe valid and generally accepted safety rules when planning, installing and using this product.
- Take proper measures to prevent unintentional operation of the product or damage to it.
- Do not attempt to disassemble this product or lines in the system while they are under pressure.
- Always depressurize the compressed air system before working on the system.

It is important that personnel use safe working practices and observe all regulations and legal requirements for safety when operating this product. When handling, operating or carrying out maintenance on this product, personnel must employ safe engineering practices and observe all local health & safety requirements & regulations. International users refer to regulations that prevail within the country of installation. Most accidents, which occur during the operation and maintenance of machinery, are the result of failure to observe basic safety rules or precautions. An accident can often be avoided by recognizing a situation that is potentially dangerous. Improper operation or maintenance of this product could be dangerous and result in an accident causing injury or death. The manufacturer cannot anticipate every possible circumstance, which may represent a potential hazard. The WARNINGS in this manual cover the most common potential hazards and are therefore not all-inclusive. If the user employs an operating procedure, an item of equipment or a method of working which is not specifically recommended by the manufacturer he must ensure that the product will not be damaged or made unsafe and that there is no risk to persons or property.

NEVER CHANGE ORIGINAL COMPONENTS WITH ALTERNATIVES

⚠ WARNING This product can expose you to chemicals including lead, which is known to the State of California to cause cancer and/or birth defects or other reproductive harm. For more information, go to www.P65Warnings.ca.gov

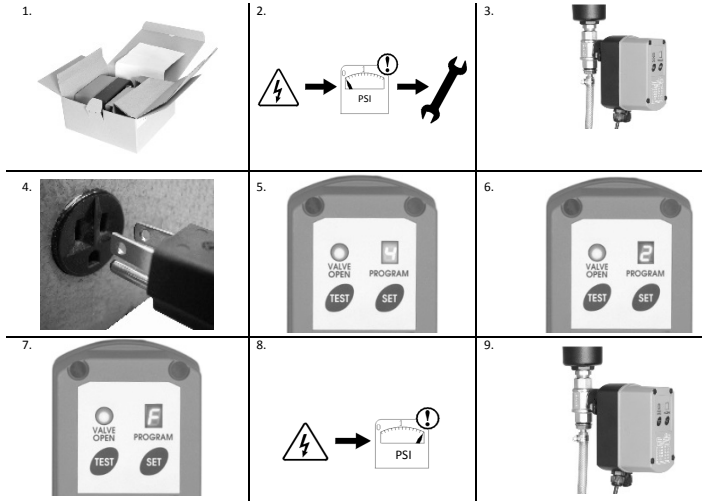

INSTALLATION INSTRUCTIONS

Before installing this product, make sure it complies with your request and that it suits your application!

1. Unpack the DRAIN and visually inspect for any transport damage incurred after leaving our factory.
2. Depressurise the system before installation or maintenance is carried out!
3. Locate a suitable condensate draining point in your compressed air system to connect your DRAIN.
- Connect the outlet to an oil/water separator.
4. After double checking that the power supply corresponds with the voltage specified on your DRAIN, you can switch it ON.
5. The DRAIN will start up in program 4 (see chart 1 on other side of this page). Any changes to the program selection will be stored. Refer to step 6 and 7 for program selections.
6. **CHANGING THE INTERVAL TIME CYCLE.**
Should the pre-set interval time cycle (4) not be suitable for your requirements, alternative interval times can be selected. Refer to chart 1 (page 6) and select the program best suited to your requirements.
Follow the procedure below to change the program:
a. Choose the preferred program (0 - 9 or -).
b. Press [SET] until your program number is displayed.
7. **CHANGING THE ROTATION TIME CYCLE.**
Should the pre-set rotation time cycle (A) not be suitable for your requirements, alternative rotation times can be selected. Refer to chart 2 (on other side of this page) and select the program best suited to your requirements.
Follow the procedure below to change the program:
a. Press [SET] and [TEST] simultaneously.
b. Press [SET] to select required time.
c. Press [TEST] to confirm selection.
d. The DRAIN is now programmed to your desired program settings and will work fully automatically.
8. Slowly pressurise the system.
9. Your DRAIN is ready for operation!

TECHNICAL SPECIFICATIONS

Maximum compressor capacity	Any size	
Pressure range	0 – 40 bar	0 – 600 psi
Supply voltage options	24VDC, 115VAC and 230VAC 50/60Hz. (depending on model!)	
Medium temperature	1 – 55 °C	34 – 131 °F
Ambient temperature	1 – 55 °C	34 – 131 °F
Timer cycle range (ON / OFF)	7 seconds to 15 minutes ON / 4 minutes to 24 hours OFF	
Actuator PCB	SMD technology	
Timer cycle indication	LED	
Test feature	Yes	
Valve type	2/2 way, motorized ball valve	
Valve orifice	12 mm	0,5"
Valve seals	FPM and Teflon	
Inlet/outlet connections	1/4, 1/2, 3/4, 1 (BSP or NPT)	
Inlet connection height	1.0 cm	0,04"
Serviceable valve	Yes	
Valve housing material	Brass nickel plated, Stainless steel available	
Power connection	Cable and plug	
Environmental protection	IP65 (NEMA4)	
Remote switch option	Yes	
Valve position indicator	Yes, Red = OPEN	

DIMENSIONS (inches)

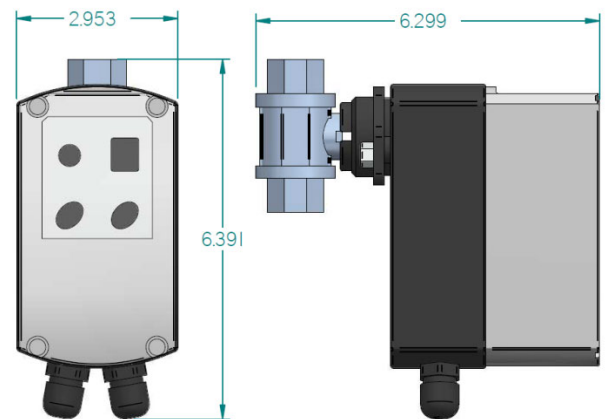

EXPLODED VIEW

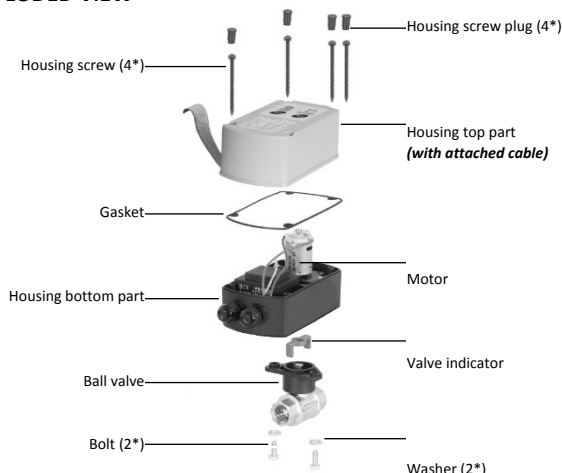

REPLACEMENT PARTS

Description	Part No.
-------------	----------

INTERVAL TIME (OFF)		
CHART 1	Program	Valve closed
	0	4 min
	1	8 min
	2	15 min
	3	30 min
	4	1 hrs
	5	2 hrs
	6	4 hrs
	7	8 hrs
	8	16 hrs
	9	24 hrs
	-	External Switching

ROTATION TIME CYCLE (ON)		
CHART 2	Program	Valve open
	A	7 seconds rotation (<i>non-stop</i>)
	B	10 seconds rotation (<i>valve stays open 3 s</i>)
	C	15 seconds rotation (<i>valve stays open 8 s</i>)
	D	20 seconds rotation (<i>valve stays open 13 s</i>)
	E	25 seconds rotation (<i>valve stays open 18 s</i>)
	F	30 seconds rotation (<i>valve stays open 23 s</i>)
	H	45 seconds rotation (<i>valve stays open 38 s</i>)
	L	1 minute rotation (<i>valve stays open 53 s</i>)
	P	5 minutes rotation (<i>valve stays open 4m 53 s</i>)
	o	15 minutes rotation (<i>valve stays open 14m 53 s</i>)

Note: When the valve is OPEN, the valve indicator is RED

BATTERY BACKUP

The DRAIN is equipped with a Power Failure Protection Safeguard. The battery back-up is intended to finish a rotation cycle in case of a power failure. The Power Failure Protection Safeguard consists of 4 AA size, 1.5V (penlight) batteries.

1. To (re)place the batteries, open the housing by unscrewing the 4 housing screws.

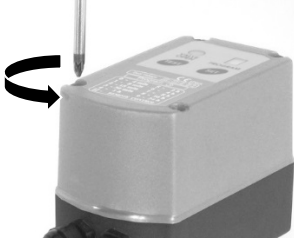

2. Place the 4 batteries and close the housing by replacing the 4 housing screws.

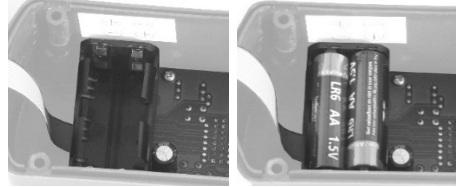

Rely as little as possible on the power failure protection safeguard. Solve the power supply problem as soon as possible!

ADDITIONAL OPTIONS (1/2)

REMOTE SWITCHING

The DRAIN can be controlled by a remote switch. See illustration below how to connect a remote control.

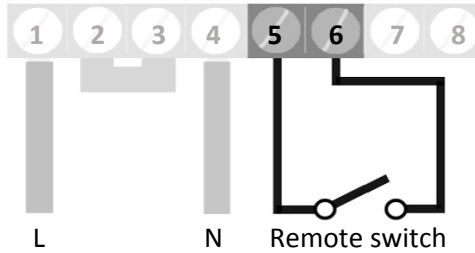
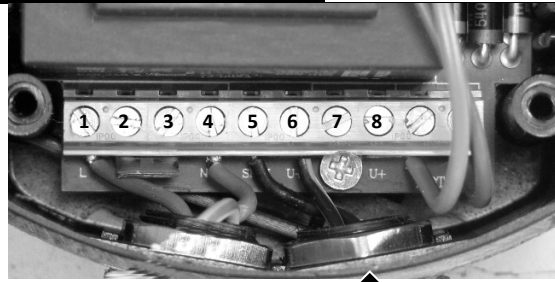

ADDITIONAL OPTIONS (2/2)

VOLTAGE SWITCH

The DRAIN can be converted to suit 115VAC or 230VAC electrical systems. Use the below mentioned diagrams to configure your drain to the corresponding electrical power supply.

