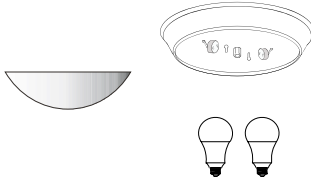
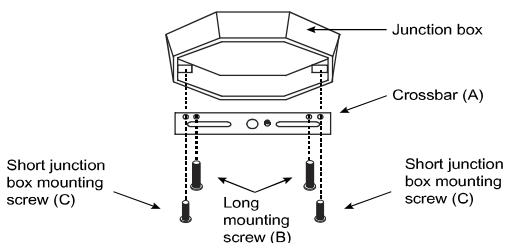

**PLEASE REVIEW THE INSTRUCTIONS AND WARNINGS LISTED BELOW PRIOR TO PROPER INSTALLATION**

WARNINGS	CAUTIONS
<ul style="list-style-type: none"> <li>• Risk of fire / electrical shock</li> <li>• LED Fixture installation requires knowledge of luminaire electrical systems.</li> <li>• Risk of electric shock – disconnect power at source before installation</li> <li>• Do not make or alter any open holes in an enclosure of wiring or electrical components during installation.</li> <li>• If lamp or luminaire exhibits abnormal operation (buzzing, flickering, minimal light, etc.), turn off power, remove lamp and contact us. For more information please visit <a href="http://www.eurilighting.com">www.eurilighting.com</a> or call our toll-free number 1-888-743-5766.</li> </ul>	<ul style="list-style-type: none"> <li>• Do not look directly at the operating LED Module.</li> <li>• Do not touch this product with wet hands.</li> <li>• Do not disassemble, repair or alter lamp.</li> <li>• Designed for indoor applications only.</li> <li>• Suitable for damp locations.</li> <li>• The luminaires shall be grounded.</li> <li>• Be careful not to touch the lamp pins to the metal housing when installing.</li> <li>• This Device is not intended for use with emergency exits or emergency lights.</li> </ul>
PACKAGING CONTENTS	SAFETY INFORMATION
<p>1 Light fixture 1 Glass shade 2 (12-watt 1100 lm A19 Bulbs) 1 Parts bag</p>  <p><b>Parts bag includes:</b></p> <ul style="list-style-type: none"> <li>A- 1 Crossbar</li> <li>B- 2 Long mounting screws</li> <li>C- 2 Short junction box mounting screws</li> <li>D- 3 Wire connectors</li> <li>E- 1 Threaded Mounting Tube</li> <li>F- 1 Nut</li> <li>G- 1 Bottom Cap</li> <li>H- 1 Finial</li> </ul>	<p><b>Read carefully for your own protection.</b></p> <ul style="list-style-type: none"> <li>• Intended for indoor use only.</li> <li>• Connect the fixture to a 120-volt, 60Hz power source (any other connectors void warranty).</li> <li>• A qualified electrician or persons with experience in household wiring should complete the install.</li> <li>• Installation of this fixture must be in accordance with the National Electric Code (NEC) and local building codes.</li> </ul>
INSTALLATION INSTRUCTIONS	
<p><b>Mounting the Crossbar</b></p> <ol style="list-style-type: none"> <li>1. Make sure the power is turned off at main fuse/breaker.</li> <li>2. Begin by screwing the two long mounting screws (B) into the crossbar (A). <b>(Figure 1)</b>.</li> <li>3. Mount crossbar (A) to junction box using the two short junction box mount screws (C) provided. <b>(Figure 1)</b>.</li> </ol>	<p><b>FIGURE 1</b></p> 

\*Product may vary from illustrations depicted in the provided guide. Please proceed with caution. Installation by a qualified Electrician is recommended.

**PLEASE REVIEW THE INSTRUCTIONS AND WARNINGS LISTED BELOW PRIOR TO PROPER INSTALLATION**

**Wiring Your Fixture**

1. Connect the black house power wire (hot) to the black lamp fixture wire and secure with a wire connector (D). **(Figure 2)**.
2. Connect the white house power wire (neutral) to the white lamp fixture wire and secure with a wire connector (D). **(Figure 2)**
3. Connect the copper lamp ground wire to an appropriate supply ground or a grounded junction box and secure with a wire connector (D). **(Figure 2)**.

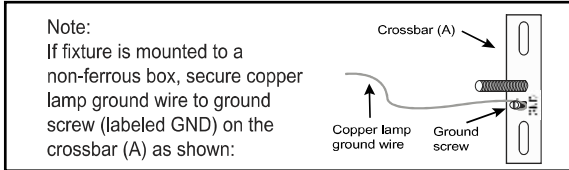

4. After all wires are secure, place the fixtures over the outlet box and align the long mounting screws (B) with the two large ends of the keyholes. Twist the base until the heads of the long mounting screws (B) slide into the narrow ends of the keyholes. Secure the fixture by tightening the long mounting screws(B). **(Figure 3)**.

**Installing the LED Bulbs**

1. Line up the two pins on the base of the bulb with the two holes in the mounting socket. **(Figure 4)**.
2. Once in place, grasp the base of the bulb and twist until the bulb clicks into place.

**Securing the Fixture**

1. Screw the threaded mounting tube (E) into the base of the fixture. Place the glass shade over the base allowing the threaded mounting tube (E) to protrude through the bottom hole in the glass. **(Figure 5)**.
2. Secure the glass shade to the fixture with the remaining nut (F). Place the bottom cap (G) onto the thread mounting tube and secure with the final (H). **(Figure 5)**.

**FIGURE 2**

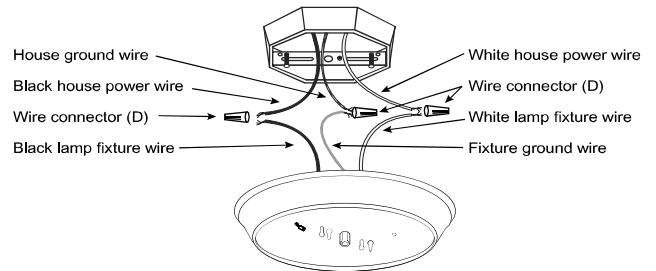

**FIGURE 3**

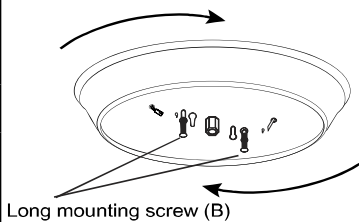

**FIGURE 4**

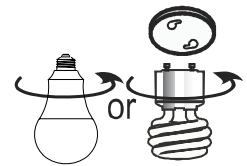

**FIGURE 5**

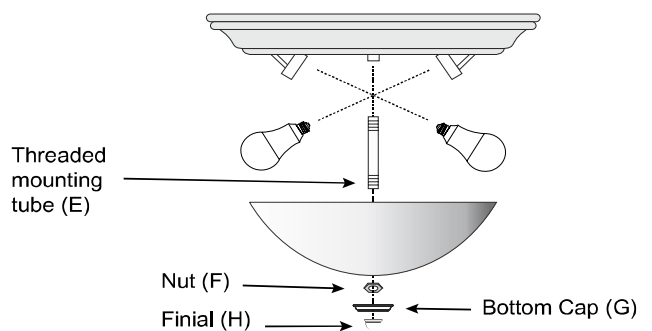

\*Product may vary from illustrations depicted in the provided guide. Please proceed with caution. Installation by a qualified Electrician is recommended.