



**M12 Hybrid Single-Ended Overmolded Receptacle Cordsets, 8-Pole (Y-Coded)**

| Product Description           |   |   |
|-------------------------------|---|---|
| Order Designation             | RKHS 8Y   | RSHS 8Y   |
|                               |    |   |
| Description                   | M12 Hybrid single-ended molded cordset with female straight receptacle, 8-pole, Y-coded, 360° shielded, chassis side thread PG9, transmits power and data (Fast Ethernet, 100 Mbit/s, Cat 5). | M12 Hybrid single-ended molded cordset with male straight receptacle, 8-pole, Y-coded, 360° shielded, chassis side thread PG9, transmits power and data (Fast Ethernet, 100 Mbit/s, Cat 5). |
| Type Contact                  | Female  | Male  |
| Number of Contacts            | 8 Pole (4 + 4)  |   |
| Standard                      | IEC 61076-2-113   |   |
| Construction Type             | Y-Coded   |   |
| Technical Data                |   |   |
| Rated Voltage                 | 50 V AC/DC  |   |
| Rated Current                 | 0.5 A (data) / 6 A (power)  |   |
| Rated Impulse Voltage         | 0.8 kV  |   |
| Pollution Degree              | 3 acc. to DIN EN 60664-1 (VDE 0110-1)   |   |
| Environmental Conditions      |   |   |
| Protection Class (IEC 60529)  | IP65, IP67, IP69K (only when mated to associated counterparts)  |   |
| Temperature Range (connector) | -40 °C to +90 °C, notice derating   |   |
| Technical Drawing             |   |   |



L = Standard length of cable

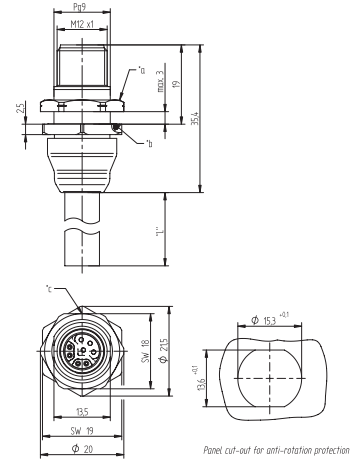
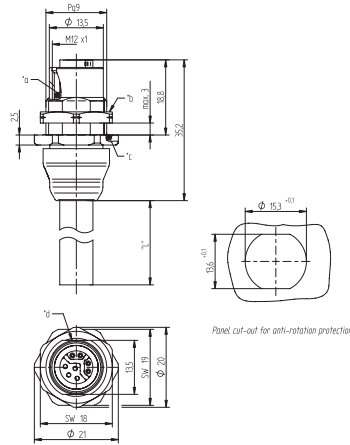



































\*a = O-Ring • \*b = Nut (SW18), enclosed separately • \*c = O-Ring, enclosed separately • \*d = anti-rotation protection

**Pin Assignment**
**8-pin, Y-coded**

- |                  |           |
|------------------|-----------|
| 1 = white/orange | 5 = blue  |
| 2 = orange       | 6 = white |
| 3 = white/green  | 7 = brown |
| 4 = green        | 8 = black |

Continued Next Page

**M12 Hybrid Single-Ended Overmolded Receptacle Cordsets, 8-Pole (Y-Coded)**
**Order Information**

| Order No. | Order Designation | No. of Pins | Jacket     | Conductor Size                                   | Characteristics   |
|-----------|-------------------|-------------|------------|--|---|
| 934925001 | RSHS 8Y-922/2 M   | 8           | PUR, black | 4x26AWG (data) and 4x0.75mm <sup>2</sup> (power) |          |
| 934925002 | RSHS 8Y-922/5 M   | 8           | PUR, black | 4x26AWG (data) and 4x0.75mm <sup>2</sup> (power) |          |
| 934925003 | RSHS 8Y-922/10 M  | 8           | PUR, black | 4x26AWG (data) and 4x0.75mm <sup>2</sup> (power) |          |
| 934925004 | RSHS 8Y-922/15 M  | 8           | PUR, black | 4x26AWG (data) and 4x0.75mm <sup>2</sup> (power) |          |
| 934925005 | RSHS 8Y-922/20 M  | 8           | PUR, black | 4x26AWG (data) and 4x0.75mm <sup>2</sup> (power) |          |
| 934925006 | RSHS 8Y-922/25 M  | 8           | PUR, black | 4x26AWG (data) and 4x0.75mm <sup>2</sup> (power) |          |
| 934926001 | RKHS 8Y-922/2 M   | 8           | PUR, black | 4x26AWG (data) and 4x0.75mm <sup>2</sup> (power) |          |
| 934926002 | RKHS 8Y-922/5 M   | 8           | PUR, black | 4x26AWG (data) and 4x0.75mm <sup>2</sup> (power) |          |
| 934926003 | RKHS 8Y-922/10 M  | 8           | PUR, black | 4x26AWG (data) and 4x0.75mm <sup>2</sup> (power) |          |
| 934926004 | RKHS 8Y-922/15 M  | 8           | PUR, black | 4x26AWG (data) and 4x0.75mm <sup>2</sup> (power) |    |
| 934926005 | RKHS 8Y-922/20 M  | 8           | PUR, black | 4x26AWG (data) and 4x0.75mm <sup>2</sup> (power) |    |
| 934926006 | RKHS 8Y-922/25 M  | 8           | PUR, black | 4x26AWG (data) and 4x0.75mm <sup>2</sup> (power) |    |