

# Model PAXLSG - PAX Lite Strain Gage Meter / Millivolt Meter



- 3 1/2-DIGIT, 0.56" (14.2 mm) HIGH RED LED READOUT
- HIGH SENSITIVITY, 10 MV FULL SCALE
- WIDE RANGE GAIN AND OFFSET ADJUSTMENTS
- BUILT-IN EXCITATION 5 OR 10 VDC
- APPLICABLE AS REGULAR MILLIVOLT INDICATOR (SINGLE-ENDED OR DIFFERENTIAL INPUT)
- SELECTABLE DECIMAL POINTS
- OVER-RANGE INDICATION
- NEMA 4X/IP65 SEALED FRONT BEZEL
- OPTIONAL CUSTOM UNITS OVERLAY W/BACKLIGHT



## GENERAL DESCRIPTION

The Model PAXLSG expands the PAX Lite capabilities into the indication of pressure, load, force, and other parameters measured with strain gages. The unit features broad range scaling and can be used with a wide variety of strain gage resistances and bridge configurations. A built-in excitation source is jumper selectable for 5 or 10 VDC @ 120 mA maximum, and can power up to four full 350 Ω bridges in load averaging applications. Although designed primarily for strain-gage indication, the PAXLSG is also ideal for single-ended or differential millivolt input applications, with full-scale input ranges from 0 to 10 mV thru 0 to 2 VDC. Adjustable scaling and offset allow direct readout in nearly any engineering unit.

The meter has a NEMA 4X/IP65 sealed bezel and extensive testing of noise effects to CE requirements, allowing the meter to provide a tough yet reliable application solution.

## SAFETY SUMMARY

All safety related regulations, local codes and instructions that appear in the literature or on equipment must be observed to ensure personal safety and to prevent damage to either the instrument or equipment connected to it. If equipment is used in a manner not specified by the manufacturer, the protection provided by the equipment may be impaired.

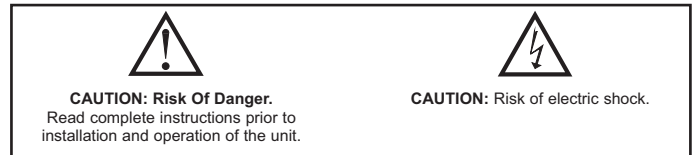

## DIMENSIONS In inches (mm)

Note: Recommended minimum clearance (behind the panel) for mounting clip installation is 2.1" (53.4) H x 5.0" (127) W.

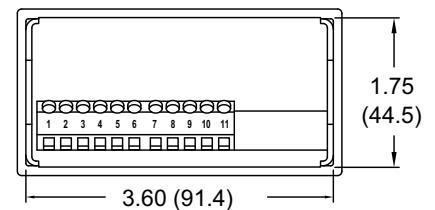
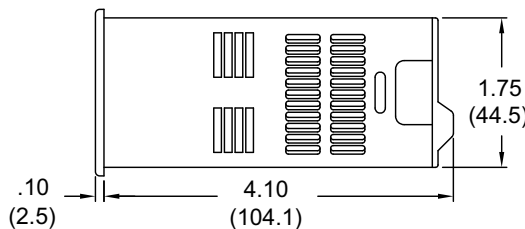
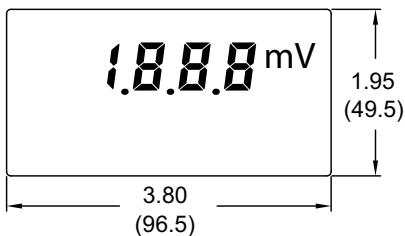

## TABLE OF CONTENTS

|  |   |                            |   |
|--|---|----------------------------|---|
| Ordering Information .....             | 2 | Wiring the Meter .....     | 4 |
| General Meter Specifications .....     | 2 | Scaling the Meter.....     | 5 |
| Accessories .....                      | 2 | Calibrating the Meter..... | 6 |
| Installing the Meter .....             | 3 | Applications .....         | 7 |
| Setting the Jumpers and Switches ..... | 3 | Warranty .....             | 8 |

## ORDERING INFORMATION

### Meter Part Numbers

|      |    |   |   |
|------|----|---|---|
| PAXL | SG | 0 | 0 |
|------|----|---|---|



SG - Strain Gage Meter

### Accessories Part Numbers

| MODEL NO. | DESCRIPTION               | PART NUMBER |
|-----------|---------------------------|-------------|
| PAXLBK    | Units Label Kit Accessory | PAXLBK30    |

## GENERAL METER SPECIFICATIONS

1. **DISPLAY:** 3 1/2-digit, 0.56" (14.2 mm) high, 7-segment red LED, (-) minus sign displayed when voltage is negative. Decimal points inserted before 1st, 2nd, or 3rd least significant digits by DIP switch selection.
2. **OVER-RANGE INDICATION:** Indicated by blanking 3 least significant digits.
3. **POWER:**  
**AC Power:** 85 to 250 VAC, 50/60 HZ, 6 VA  
**Isolation:** 2300 Vrms for 1 min. to all inputs.
4. **INPUT SIGNAL:** Single-ended or differential input,  $\pm 2.0$  V max. Gain (Sensitivity) is adjustable from 200 Units of Numerical Readout/millivolt input (gives full scale readout of 1999 at 10 mV input), to less than 1 Unit of Numerical Readout/mV (gives full scale readout of 1999 at 2.0 V input). Maximum common mode voltage swing with respect to signal ground, 0 to 7 V.  
**Note:** Absolute maximum voltage that can be applied between the two input terminals or between input and signal common is 50 VDC.
5. **INPUT IMPEDANCE:** 100 M $\Omega$
6. **LINEARITY:**  $\pm(0.05\% \pm 1 \text{ digit})$
7. **LOW FREQUENCY NOISE REJECTION:**  
**Normal Mode Rejection:** 84 dB @ 50/60 Hz  
**Common Mode Rejection:** 50 dB with respect to excitation common; 110 dB with respect to earth ground.
8. **RESPONSE TIME:** 2.0 seconds to settle from step input.
9. **READING RATE:** 2.5 updated readings / second, nominal.
10. **EXCITATION SUPPLY:**  
**Jumper Selectable:** 5 VDC @ 60 mA max.,  $\pm 2\%$   
                           10 VDC @ 120 mA max.,  $\pm 2\%$   
**Temperature coefficient (ratio metric):** 20 ppm/ $^{\circ}\text{C}$
11. **ENVIRONMENTAL CONDITIONS:**  
**Operating Temperature:** 0 to 60  $^{\circ}\text{C}$   
**Storage Temperature:** -40 to 80  $^{\circ}\text{C}$   
**Operating and Storage Humidity:** 85% max. relative humidity (non-condensing)  
**Span Temperature Coeff.:** 100 PPM/ $^{\circ}\text{C}$   
**Offset Temperature Coeff.:** 100 PPM/ $^{\circ}\text{C}$   
**Vibration to IEC 68-2-6:** Operational 5 to 150 Hz, 2 g.  
**Shock to IEC 68-2-27:** Operational 30 g  
**Altitude:** Up to 2000 meters
12. **CERTIFICATIONS AND COMPLIANCES:**  
**CE Approved**  
     EN 61326-1 Immunity to Industrial Locations  
     Emission CISPR 11 Class A  
     IEC/EN 61010-1  
     RoHS Compliant  
     UL Listed: File #E179259  
     Type 4X Outdoor Enclosure rating (Face only)  
     IP65 Enclosure rating (Face only)  
     IP20 Enclosure rating (Rear of unit)  
     Refer to EMC Installation Guidelines section of the bulletin for additional information.
13. **CONNECTIONS:** High compression cage-clamp terminal block  
**Wire Strip Length:** 0.3" (7.5 mm)  
**Wire Gauge:** 30-14 AWG copper wire  
**Torque:** 4.5 inch-lbs (0.51 N-m) max.
14. **CONSTRUCTION:** This unit is rated for NEMA 4X/IP65 outdoor use. IP20 Touch safe. Installation Category II, Pollution Degree 2. One piece bezel/case. Flame resistant. Panel gasket and mounting clip included.
15. **WEIGHT:** 0.65 lbs. (0.24 kg)

## ACCESSORIES

### UNITS LABEL KIT (PAXLBK)

Each meter has a units indicator with backlighting that can be customized using the Units Label Kit. The backlight is controlled by a DIP switch.

## 1.0 INSTALLING THE METER

### INSTALLATION

The PAX Lite meets NEMA 4X/IP65 requirements when properly installed. The unit is intended to be mounted into an enclosed panel. Prepare the panel cutout to the dimensions shown. Remove the panel latch from the unit. Slide the panel gasket over the rear of the unit to the back of the bezel. The unit should be installed fully assembled. Insert the unit into the panel cutout.

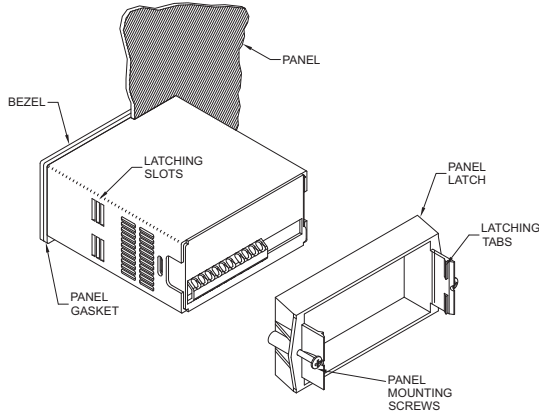

While holding the unit in place, push the panel latch over the rear of the unit so that the tabs of the panel latch engage in the slots on the case. The panel latch should be engaged in the farthest forward slot possible. To achieve a proper seal, tighten the latch screws evenly until the unit is snug in the panel (Torque to approximately 7 in-lbs [79N-cm]). Do not over-tighten the screws.

### INSTALLATION ENVIRONMENT

The unit should be installed in a location that does not exceed the maximum operating temperature and provides good air circulation. Placing the unit near devices that generate excessive heat should be avoided.

The bezel should be cleaned only with a soft cloth and neutral soap product. Do NOT use solvents. Continuous exposure to direct sunlight may accelerate the aging process of the bezel.

#### PANEL CUT-OUT

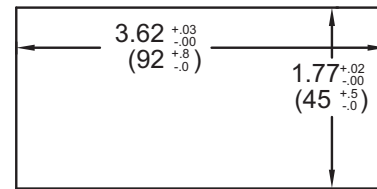

## 2.0 SETTING THE SWITCHES AND JUMPERS

The meter has switches which must be checked and/or changed prior to applying power. To access the switches, remove the meter base from the case by firmly squeezing and pulling back on the side rear finger tabs. This should lower the latch below the case slot (which is located just in front of the finger tabs). It is recommended to release the latch on one side, then start the other side latch.

### Excitation Range Jumper

A jumper is used for selection of the 5 or 10 volt range. It is important that only one jumper position is used at a time.

### Set-Up DIP Switches

Two banks of DIP switches are located inside the meter. The 9 position bank of switches are used for calibrating the meter. The values of these switches are discussed in section 5.0 Calibrating the Meter.

The bank of 4 switches located near the front display are used for the selection of decimal points and backlight annunciator. Selecting "ON" position enables the function.

| SWITCH | FUNCTION                              |
|--------|---------------------------------------|
| 1      | Decimal Point 1 (000.0)               |
| 2      | Decimal Point 2 (00.00)               |
| 3      | Decimal Point 3 (0.000)               |
| 4      | Backlight Annunciator for Units Label |

### PAXLSG Jumper Selection

JUMPER SELECTIONS  
The  indicates factory setting

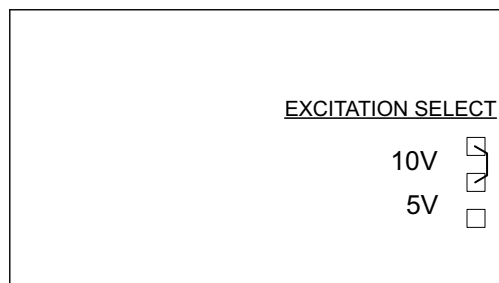

↓ REAR TERMINALS ↓

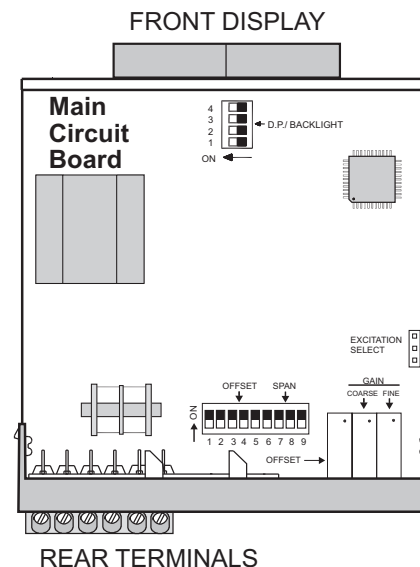

### 3.0 WIRING THE METER

#### WIRING OVERVIEW

Electrical connections are made via screw-clamp terminals located on the back of the meter. All conductors should conform to the meter's voltage and current ratings. All cabling should conform to appropriate standards of good installation, local codes and regulations. It is recommended that power supplied to the meter (AC) be protected by a fuse or circuit breaker.

When wiring the meter, compare the numbers embossed on the back of the meter case against those shown in wiring drawings for proper wire position. Strip the wire, leaving approximately 0.3" (7.5 mm) bare lead exposed (stranded wires should be tinned with solder.) Insert the lead under the correct screw-clamp terminal and tighten until the wire is secure. (Pull wire to verify tightness.)

#### EMC INSTALLATION GUIDELINES

Although Red Lion Controls products are designed with a high degree of immunity to Electromagnetic Interference (EMI), proper installation and wiring methods must be followed to ensure compatibility in each application. The type of the electrical noise, source or coupling method into a unit may be different for various installations. Cable length, routing, and shield termination are very important and can mean the difference between a successful or troublesome installation. Listed are some EMI guidelines for a successful installation in an industrial environment.

1. A unit should be mounted in a metal enclosure, which is properly connected to protective earth.
2. Use shielded cables for all Signal and Control inputs. The shield connection should be made as short as possible. The connection point for the shield depends somewhat upon the application. Listed below are the recommended methods of connecting the shield, in order of their effectiveness.
  - a. Connect the shield to earth ground (protective earth) at one end where the unit is mounted.
  - b. Connect the shield to earth ground at both ends of the cable, usually when the noise source frequency is over 1 MHz.
3. Never run Signal or Control cables in the same conduit or raceway with AC power lines, conductors, feeding motors, solenoids, SCR controls, and heaters, etc. The cables should be run through metal conduit that is properly grounded. This is especially useful in applications where

cable runs are long and portable two-way radios are used in close proximity or if the installation is near a commercial radio transmitter. Also, Signal or Control cables within an enclosure should be routed as far away as possible from contactors, control relays, transformers, and other noisy components.

4. Long cable runs are more susceptible to EMI pickup than short cable runs.
5. In extremely high EMI environments, the use of external EMI suppression devices such as Ferrite Suppression Cores for signal and control cables is effective. The following EMI suppression devices (or equivalent) are recommended:

Fair-Rite part number 0443167251 (Red Lion Controls #FCOR0000)

Line Filters for input power cables:

Schaffner # FN2010-1/07 (Red Lion Controls #LFIL0000)

6. To protect relay contacts that control inductive loads and to minimize radiated and conducted noise (EMI), some type of contact protection network is normally installed across the load, the contacts or both. The most effective location is across the load.
  - a. Using a snubber, which is a resistor-capacitor (RC) network or metal oxide varistor (MOV) across an AC inductive load is very effective at reducing EMI and increasing relay contact life.
  - b. If a DC inductive load (such as a DC relay coil) is controlled by a transistor switch, care must be taken not to exceed the breakdown voltage of the transistor when the load is switched. One of the most effective ways is to place a diode across the inductive load. Most Red Lion products with solid state outputs have internal zener diode protection. However external diode protection at the load is always a good design practice to limit EMI. Although the use of a snubber or varistor could be used.

Red Lion part numbers: Snubber: SNUB0000

Varistor: ILS11500 or ILS23000

7. Care should be taken when connecting input and output devices to the instrument. When a separate input and output common is provided, they should not be mixed. Therefore a sensor common should NOT be connected to an output common. This would cause EMI on the sensitive input common, which could affect the instrument's operation.

Visit [www.redlion.net/emi](http://www.redlion.net/emi) for more information on EMI guidelines, Safety and CE issues as they relate to Red Lion products.

#### 3.1 POWER WIRING

AC Power  
Terminal 1: VAC  
Terminal 2: VAC

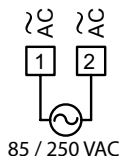

Excitation Power  
Terminal 3: Common  
Terminal 4: Excitation+

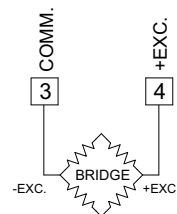

5 VDC @ 60 mA max, ±2%  
10 VDC @ 120 mA max, ±2%

#### 3.2 INPUT SIGNAL WIRING

##### 2-Wire Single Ended Input

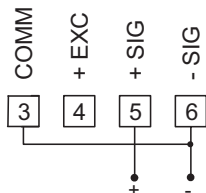

##### 4-Wire Bridge Input

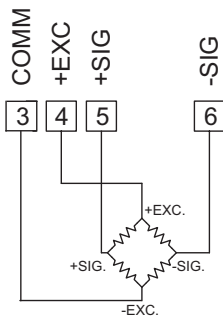

##### 6-Wire Bridge Input

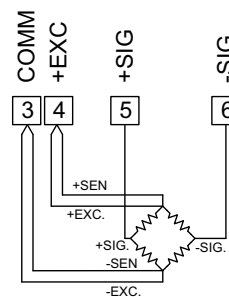

#### DEADLOAD COMPENSATION

In some cases, the combined deadload and liveload output may exceed the range of the input. To use this range, the output of the bridge can be offset a small amount by applying a fixed resistor across one arm of the bridge. This shifts the electrical output of the bridge downward to

within the operating range of the meter. A 100 K ohm fixed resistor shifts the bridge output approximately -10 mV (350 ohm bridge, 10 V excitation).

Connect the resistor between +SIG and -SIG. Use a metal film resistor with a low temperature coefficient of resistance.

## BRIDGE COMPLETION RESISTORS

For single strain gage applications, bridge completion resistors must be employed externally to the meter. Only use metal film resistors with a low temperature coefficient of resistance.

Load cells and pressure transducers are normally implemented as full resistance bridges and do not require bridge completion resistors.

## 4.0 SCALING THE METER

### PAXLSG SCHEMATIC

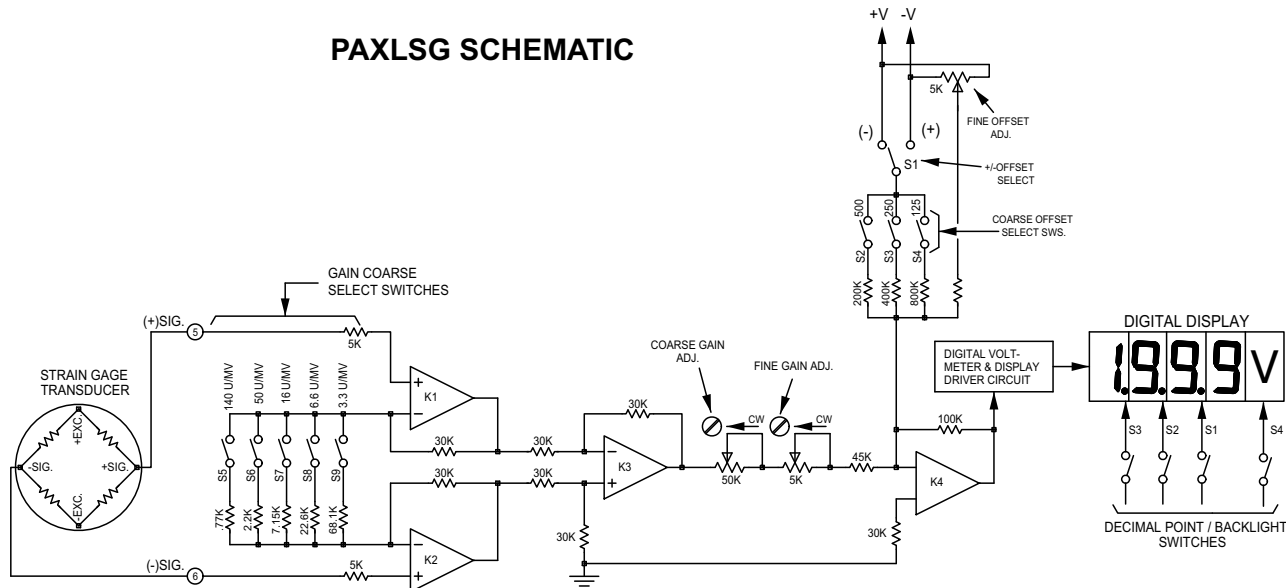

## DESCRIPTION OF OPERATION

The Pax Lite Strain Gage Indicator (PAXLSG) consists of a digital voltmeter combined with a high-gain, differential input amplifier that has provision for wide range scaling adjustment (shown above). The unit also incorporates an excitation power supply (5 or 10 VDC) that delivers up to 120 mA. In the simplified schematic above, K1, K2, and K3 form a high-gain, high-stability, differential input preamplifier with a single ended output. The gain of this preamplifier is set up by coarse gain select switches S5 through S9. These switches can be turned on in combination to provide discrete steps of gain-range adjustment. The output of the preamplifier (K3 output) is applied to the summing amplifier (K4) through coarse and fine adjustable potentiometers. These adjustable potentiometers provide final vernier gain adjustment over a range of slightly more than 2:1. An adjustable offset voltage signal is also added in at the input of K4 for zero-balance or for applications where the transfer curve must be offset from zero.

## GAIN ADJUSTMENTS

Gain is defined as the Units of Numerical change seen on the display per mV (millivolt) of input signal change (disregarding display decimal points). In effect, gain determines the slope of the transfer curve and is expressed in Units/mV.

$$\text{GAIN} = \frac{(\text{Max. Num. Readout}) - (\text{Min. Num. Readout})}{(\text{Max. mV Input Sig.}) - (\text{Min. mV Input Sig.})}$$

**Note:** Disregarded Decimal Points in Readout.

For example, if an PAXLSG is to display 50.0 @ 2 mV (min.) and 169.0 @ 19 mV (max.), the required gain will be:

$$\text{GAIN} = \frac{1690 \text{ Units} - 500 \text{ Units}}{19 \text{ mV} - 2 \text{ mV}} = 70 \text{ Units/mV}$$

**Note:** Remember, display decimal points are disregarded.

To establish this gain, the settings of the coarse gain select switches must first be determined. These switches establish the maximum end of the 2:1 adjustment range of the coarse and fine vernier gain adjustments.

## COARSE GAIN SELECT SWITCHES

Each of the coarse gain select switches is marked with the amount of maximum gain it will contribute when turned on. They are turned on singly or in combination (adding up each of their gain contributions), to arrive at a maximum gain value that is just above the desired gain value. To achieve the desired gain of 70 Units/mV in the example just given, the following switches would be turned on:

$$S6 (\text{Gain } 50) + S7 (\text{Gain } 16) + S8 (\text{Gain } 6.6) = 72.6 \text{ Units/mV}$$

With these switches ON, the coarse and fine vernier adjustments cover a gain range from about 36 Units/mV (½ of max.) to 72.6 Units/mV. The required gain of 70 Units/mV falls within this adjustable range.

## COARSE AND FINE GAIN ADJUSTMENTS

Once the gain select switches have been set, the final gain calibration is made with the Coarse and Fine Gain adjustments. Both of these adjustments are 15-Turn, screwdriver adjustable potentiometers that increase gain with clockwise rotation. The Coarse adjustment has a 2:1 range. The Fine adjustment has a range of 5-10% (depending on the setting of the Coarse adjustment). Both pots are located at the rear of the meter.

## OFFSET ADJUSTMENTS

Offset adjustments move the transfer curve up-and-down along the vertical axis without changing the slope (Gain). They are used to "balance" the output of transducers or to intentionally introduce an offset, such as tare-load compensation. The Fine Offset Adjustment is a 15-turn screwdriver adjustable potentiometer, located at the rear of the meter. It has a range of ±125 Numerical Units of offset which is sufficient for balancing the output of most transducers.

The Coarse Offset Switches (S2, 3, and 4) can be used to add additional steps of offset. Like the coarse gain select switches, the offset switches are marked with the approximate value of offset contributed by each switch, and they can be turned on in combinations with each switch, contributing its value to the total. Switch S1 selects the polarity of the offset signal and can be set to either add or subtract the offset contribution of the switches. The maximum offset that can be obtained with all switches ON and the Fine Offset at its maximum is ±1000, which is one half of the full scale readout.



## 5.0 CALIBRATING THE METER

There are three different methods that can be used to calibrate the PAXLSG, and the method chosen depends largely on the nature of the application. The three methods are:

### VOLTAGE CALIBRATION

In this method, the transducer signal is simply replaced with an accurately measured input voltage that can be varied through the range normally delivered by the transducer (See Voltage Calibration Circuit, below). The PAXLSG is then adjusted to provide the proper readout.

### SYSTEM CALIBRATION

In this method, the transducer is connected to the input of the PAXLSG in the final installation, or in a bench set-up simulating the actual installation. Accurately known inputs are then applied to the transducer (i.e. load, pressure, force, etc.), and the PAXLSG adjustments are made to provide the desired indication. This method is usually preferable to the Voltage Calibration method since it calibrates both the transducer and the PAXLSG as a combination, and reduces the inherent risk of inaccuracy or errors accumulated by separate calibration. However, it can only be used in applications where the parameter to be indicated can be easily varied and accurately measured or established. It is also very awkward to use if an offset or transducer unbalance must be dealt with because of Offset/Gain adjustment interaction.

### COMBINATION VOLTAGE/SYSTEM CALIBRATION

In applications where tare-load, offset, or substantial transducer unbalance exists and where high accuracy is required in the final indication, it may be desirable to voltage calibrate the unit first to get it very close to its final settings. Then, after final installation, the unit can be "tweaked" to its final settings while using accurately known inputs to the system. These various factors make it impossible to set up one calibration procedure to cover all applications. However, using the following information on Voltage Calibration together with the examples given should provide a good basis for handling virtually any calibration requirement.

### CALIBRATION EXAMPLE

"Voltage Calibration" can be easily performed for any application, using the calibration circuit shown below.

#### VOLTAGE CALIBRATION CIRCUIT (Using 350 Ohm Dummy Bridge)

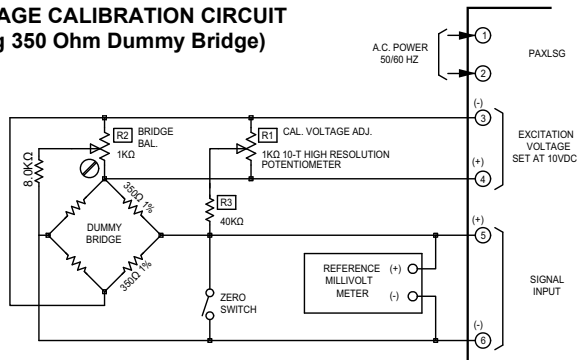

This 350 Ohms "Dummy Bridge" circuit delivers calibration voltages in ranges of 0 to ±22 mV, 0 to +44 mV, or 0 to -44 mV, depending on the setting of R2. The range can be increased or decreased by adjusting the value of R3 (shown as 40 K). An accurate reference millivoltmeter is used to set up the calibration voltage, and a "Zero Switch" facilitates balancing without readjusting the calibration voltage. High-stability metalized resistors (1% tol.) should be used. The use of a dummy bridge insures a common-mode voltage during calibration that is very similar to that of the actual transducer.

#### SET-UP:

Before starting the procedure, the Input Swing Voltage (Vs), the Readout Span (Rs) and the required GAIN must be determined.

#### WHERE:

Rs = (Max. Numerical Display) - (Min. Numerical Display) Disregard Decimal Points

Vs = (mV in @ Max. Display) - (mV in @ Min. Display)

$$GAIN = \frac{R_s}{V_s} = \text{Units/mV}$$

**EXAMPLE:** Readout is to be 5.00 Units @ 2 mV minimum, and 15.00 Units @ 18 mV maximum. The transducer is a 350 Ω strain-gage bridge requiring 10 VDC excitation.

Rs = 1500 - 500 = 1000 Units

Vs = 18 mV - 2 mV = 16 mV

$$GAIN = \frac{1000}{16} = 62.5 \text{ Units/mV}$$

**Note:** While most strain gage readout applications are zero-based (i.e. zero readout @ zero input) this example was intentionally chosen because it included an offset reading at zero input. It will be used in the Calibration Procedure below to illustrate the most convenient way to handle offset situations without excessive interaction of gain and offset adjustments. If a zero-based example had been given, the minimum readout and input voltage would have both been zero. Rs and Vs would then simply be the maximum values of readout and input voltage respectively, gain would just be the ratio of (Max. Readout/Max. Input mV), and Steps 7 and 8 of the procedure below could be eliminated.

### CALIBRATION PROCEDURE

1. Set the Coarse Gain Select Switches, S5 through S9 to establish a maximum range just exceeding the required gain. Referring to the example given, the required gain was calculated to be 62.5 Units/mV. Setting switches S6 and S7 ON gives 50 + 16 = 66 Units/mV, which is just above the required amount. The following chart gives an approximate gain adjustment value for each switch:

| SWITCH NUMBER | SPAN VALUE |
|---------------|------------|
| 5             | 140        |
| 6             | 50         |
| 7             | 16         |
| 8             | 6.6        |
| 9             | 3.3        |

- All offset switches, S2, 3, and 4, should be off.
- Connect the unit to the Calibration Circuit as shown. Set the excitation voltage range jumper to the 10 V position.
- Place unit in the case and turn power on to the unit. Allow 10 minutes of warm-up time for stabilization.
- Close the "Zero Switch" of the calibration circuit to obtain zero input voltage. Adjust the fine offset control to get a zero readout.
- Open the "Zero Switch" of the calibrating circuit and set the input voltage to the calculated swing voltage, Vs. (Vs is 16 mV in the example given.) Now, adjust the Gain Coarse and Fine Controls to get a readout equal to the Readout Span. (Rs = 1000 Units in the example given.)
- Repeat Step 4 and readjust zero if required. If zero readjustment was needed, repeat Step 5, then back to Step 4, etc., until Zero and Rs readings are acceptable.

**Note:** Steps 7 and 8 are not required in zero-based applications.

7. Set the calibration voltage to the minimum input level (2 mV in this example). Record the meter reading (125 in this example). Power the meter down and remove it from the case. Set the Coarse Offset Select Switches to get the corresponding minimum readout (add the switch offset value(s) to the recorded meter reading). In the example given, the minimum readout was 500 units @ 2 mV, therefore setting

switches 3 and 4 gives us 125 (meter reading) + 125 (SW4) + 250 (SW3) = 500. The following chart gives an approximate offset adjustment value for each switch.

| SWITCH NUMBER | SPAN VALUE |
|---------------|------------|
| 2             | 500        |
| 3             | 250        |
| 4             | 125        |

8. Place unit in the case and turn power on to the unit. Use the fine offset adjustment to fine tune the desired minimum reading (500 in this

example). Vary the input from the minimum to maximum levels and check the corresponding readouts. Fine-tune if necessary by readjusting the fine gain adjustment at the maximum end and the fine offset adjustment at the minimum end. (In the example, readout is 500 @ 2 mV min. and 1500 @ 18 mV max.) Alternate between minimum and maximum inputs as required until readout is within desired tolerance at the extremes.9. Set appropriate decimal point switch (S2 for the example given).

The unit is now ready for installation.

## 6.0 APPLICATIONS

### EXAMPLE #1 PRESSURE READOUT & SYSTEM CALIBRATION

This illustration depicts a common application using an PAXLSG with a strain-gage pressure transducer for pressure indication. The gain required to display 150 Units @ 20 mV is 150/20, or 7.5 Units/mV. Setting the Coarse Gain Select Switches S8 and S9 ON, gives a gain range of 6.6 + 3.3, or 9.9 Units/mV maximum, which brackets the required gain. The transducer curve is zero-based (i.e. zero readout at zero input), and can be easily System Calibrated. A variable pressure input is applied to the transducer with a "Dead-Weight Tester" and the Fine Offset is adjusted to give a readout of zero with no pressure applied. Then 150 PSI is applied, the Coarse and Fine Gain controls are adjusted for a readout of 150. Pressure is removed, zero is checked and readjusted with the Fine Offset control if needed. Pressure is varied between zero and maximum, with the Fine Gain and Offset adjustments retrimmed as needed until the readout is within tolerance.

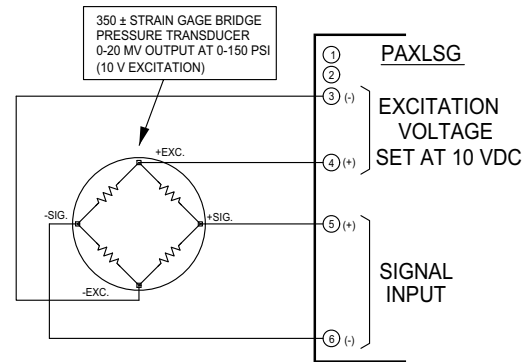

### EXAMPLE #2 THE MODEL PAXLSG AS A MILLIVOLT METER

The PAXLSG can be used as a scalable millivolt meter and will accept either single-ended or differential inputs when connected as shown. Input signals are referenced to the negative (common) side of the excitation supply (Terminal 3). Maximum common-mode voltage for differential input) is 0 to +7 VDC.

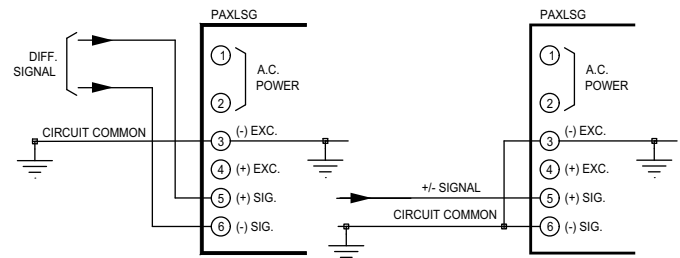

### EXAMPLE #3 MULTIPLE LOAD-CELL INPUT, AVERAGE READING

The 120 mA excitation output capability of the PAXLSG allows it to operate multiple strain gage bridges. In this example, it is used to indicate the quantity of granular material held in a hopper that is supported by three load cells in a tripod mounting arrangement. The tare-weight of the empty hopper is about 30% of the full weight, requiring a significant offset for a zero readout when empty. The PAXLSG is first Voltage-Calibrated (using the known output of the load cells at the empty and full conditions). Then the unit is installed and fine trimmed (System Calibration) using known loads.

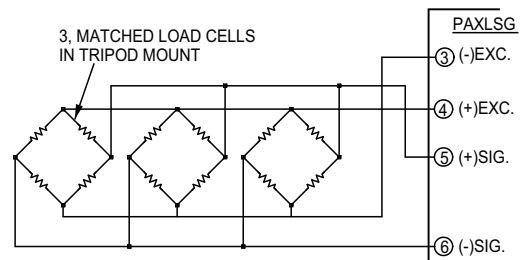

#### **LIMITED WARRANTY**

(a) Red Lion Controls Inc., (the "Company") warrants that all Products shall be free from defects in material and workmanship under normal use for the period of time provided in "Statement of Warranty Periods" (available at [www.redlion.net](http://www.redlion.net)) current at the time of shipment of the Products (the "Warranty Period"). **EXCEPT FOR THE ABOVE- STATED WARRANTY, COMPANY MAKES NO WARRANTY WHATSOEVER WITH RESPECT TO THE PRODUCTS, INCLUDING ANY (A) WARRANTY OF MERCHANTABILITY; (B) WARRANTY OF FITNESS FOR A PARTICULAR PURPOSE; OR (C) WARRANTY AGAINST INFRINGEMENT OF INTELLECTUAL PROPERTY RIGHTS OF A THIRD PARTY; WHETHER EXPRESS OR IMPLIED BY LAW, COURSE OF DEALING, COURSE OF PERFORMANCE, USAGE OF TRADE OR OTHERWISE.** Customer shall be responsible for determining that a Product is suitable for Customer's use and that such use complies with any applicable local, state or federal law.

(b) The Company shall not be liable for a breach of the warranty set forth in paragraph (a) if (i) the defect is a result of Customer's failure to store, install, commission or maintain the Product according to specifications; (ii) Customer alters or repairs such Product without the prior written consent of Company.

(c) Subject to paragraph (b), with respect to any such Product during the Warranty Period, Company shall, in its sole discretion, either (i) repair or replace the Product; or (ii) credit or refund the price of Product provided that, if Company so requests, Customer shall, at Company's expense, return such Product to Company.

(d) **THE REMEDIES SET FORTH IN PARAGRAPH (c) SHALL BE THE CUSTOMER'S SOLE AND EXCLUSIVE REMEDY AND COMPANY'S ENTIRE LIABILITY FOR ANY BREACH OF THE LIMITED WARRANTY SET FORTH IN PARAGRAPH (a).**