





# LEDAL INSTALLATION AND USER'S GUIDE

OUTDOOR SERIES | RPT-P-LEDAL

## READ AND FOLLOW ALL SAFETY INSTRUCTIONS

- To reduce the risk of death, personal injury or property damage from fire, electric shock, falling parts, cuts/abrasions, and other hazards please read all warnings and instructions included with and on the fixture box and all fixture labels.
- Before installing, servicing, or performing routine maintenance up on this equipment, follow these general precautions.
- Installation and service of luminaires should be performed by a qualified licensed electrician.
- Maintenance of the luminaires should be performed by person(s) familiar with the luminaires' construction and operation and any hazards involved. Regular fixture maintenance programs are recommended.
- It will occasionally be necessary to clean the outside of the refractor/lens. Frequency of cleaning will depend on ambient dirt level and minimum light output which is acceptable to user. Refractor/lens should be washed in a solution of warm water and any mild, non-abrasive household detergent, rinsed with clean water and wiped dry.
- Should optical assembly become dirty on the inside, wipe refractor/lens and clean in above manner, replacing damaged gaskets as necessary.
- DO NOT INSTALL DAMAGED PRODUCT! This luminaire has been properly packed so that no parts should have been damaged during transit. Inspect to confirm. Any part damaged or broken during or after assembly should be replaced.
- These instructions do not purport to cover all details or variations in equipment nor to provide every possible contingency to meet in connection with installation, operation, or maintenance.
- Suitable for wet location and operation in ambient not exceeding 40

 <p style="text-align: center;"><b>WARNING</b> <b>RISK OF ELECTRIC SHOCK</b></p> <p>Disconnect or turn off power before installation or servicing. Verify that supply voltage is correct by comparing it with the luminaire label information.</p> <p>Make all electrical and grounded connections in accordance with the National Electrical Code (NEC) and any applicable local code requirements.</p> <p>All wiring connections should be capped with UL approved recognized wire connectors</p>	 <p style="text-align: center;"><b>WARNING</b> <b>RISK OF BURN</b></p> <p>Allow lamp/fixture to cool before handling. Do not touch enclosure or light source.</p> <p>Do not exceed maximum wattage marked on luminaire label.</p> <p>Follow all manufacturer's warnings, recommendations and restrictions for: driver type, burning position, mounting locations/methods, replacement and recycling.</p>
 <p style="text-align: center;"><b>WARNING</b> <b>RISK OF INJURY</b></p> <p>Wear gloves and safety glasses at all times when removing luminaire from carton, installing, servicing or performing maintenance.</p> <p>Avoid direct eye exposure to the light source while it is on.</p>	 <p style="text-align: center;"><b>WARNING</b> <b>RISK OF FIRE</b></p> <p>Keep combustible and other materials that can burn, away from lamp/lens.</p> <p>Do not operate in close proximity to persons, combustible materials or substances affected by heat or drying.</p>

**RemPhos** by Light Efficient Design  
lighting on target

FOR PRODUCT INFO ("LED" MODEL #) CONTACT.....Light Efficient Design • 188 S. Northwest Highway • Cary, IL 60013 • 847.380.3540 • led-llc.com  
FOR PRODUCT INFO ("RP" MODEL #) CONTACT.....RemPhos by Light Efficient Design • 30 Log Bridge Road, Building 200 • Middleton, MA 01949 • 877.997.3674 • remphos.com

08.24.18 Information is subject to change without notice.

## INSTRUCTIONS FOR INSTALLATION OF BRACKET

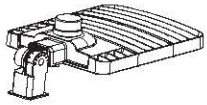

Slip Fitter

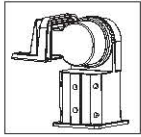

A

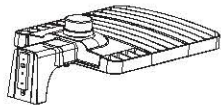

Square Pole Mount

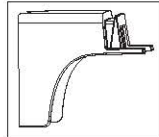

B

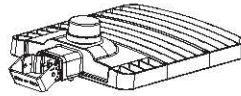

Trunnion

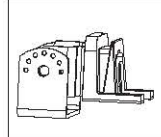

C

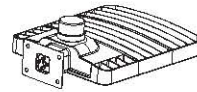

Wall Mount

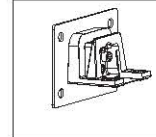

F

### Slip Fitter

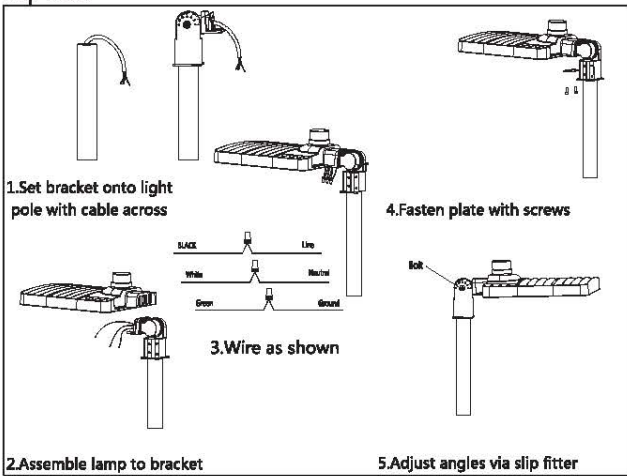

### Pole Mount

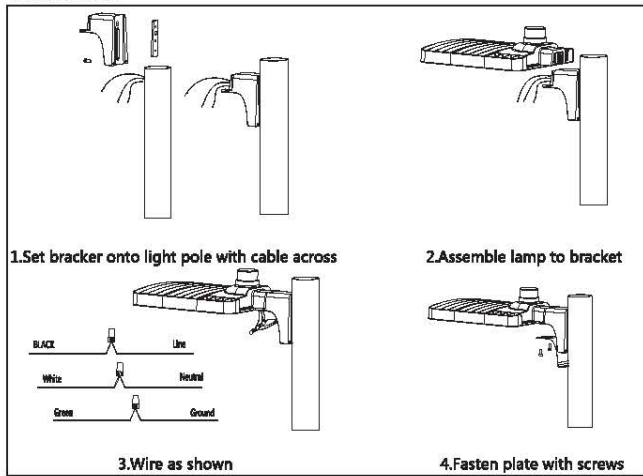

### Trunnion

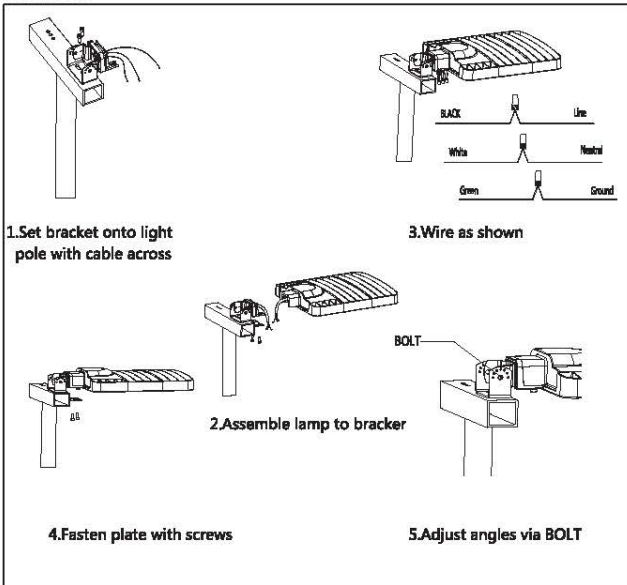

### Wall Mount

