



N-Tron<sup>®</sup> Series

700/7000 Models - Volume I

Managed Industrial Ethernet Switches

Hardware Manual | August 2019  
LP0988 | Revision B

## **COPYRIGHT**

©2019 Red Lion Controls, Inc. All rights reserved. Red Lion, the Red Lion logo, N-Tron and N-Ring are trademarks of Red Lion Controls, Inc. All other company and product names are trademarks of their respective owners.

Red Lion Controls, Inc.  
20 Willow Springs Circle  
York, PA 17406

## **CONTACT INFORMATION:**

Inside US: +1 (877) 432-9908  
Outside US: +1 (717) 767-6511

Website: [www.redlion.net](http://www.redlion.net)

Support: [support.redlion.net](http://support.redlion.net)

## Table of Contents

Preface .....	iv
Disclaimer .....	v
Compliance Information .....	v
Part 15 of the Federal Communications Commission (FCC) - A Rules: Interference .....	v
Déclaration de conformité FCC .....	v
Industry Canada .....	v
Environmental Impact Statement .....	v
Toxic Emissions .....	v
Trademark Acknowledgments .....	v
Release Notes and Document Updates .....	v
Publication History .....	v
Related Documents .....	vi
Document Comments .....	vi
Additional Product Information .....	vi
Cautions and Warnings / Mises en Garde et Avertissements .....	vi
General Safety Cautions and Warnings / Précautions et Avertissements de Sécurité Générale .....	vi
Electrical Safety Warnings / Avertissements de Sécurité électrique .....	vii
Environmental Safety Cautions and Warnings / Sécurité Environnementale Mises en Garde et Avertissements .....	viii
Hazardous Location Warnings / Les Avertissements d'Emplacement Dangereux .....	viii
Laser Safety Warnings / Avertissements de Sécurité Laser .....	x
Regulatory Certifications and Approvals .....	xi
<b>Chapter 1 Product Overview .....</b>	<b>1-1</b>
1.1 Common Features .....	1-1
1.1.1 Connectivity .....	1-1
1.1.2 Performance .....	1-1
1.1.3 Environmental .....	1-1
1.1.4 Monitoring .....	1-1
1.1.5 Security .....	1-1
1.2 Available Models .....	1-2
1.3 708TX .....	1-3
1.3.1 Features and Benefits .....	1-3
1.3.2 708TX Specifications .....	1-4
1.3.3 708TX Dimensions .....	1-5
1.4 708FX2 .....	1-6
1.4.1 Features and Benefits .....	1-6
1.4.2 708FX2 Specifications .....	1-7



1.4.3	708FX2 Dimensions	1-8
1.5	708M12	1-9
1.5.1	Features and Benefits	1-9
1.5.2	708M12 Specifications	1-10
1.5.3	708M12 Dimensions	1-11
1.6	716TX	1-12
1.6.1	Features and Benefits	1-12
1.6.2	716TX Specifications	1-13
1.6.3	716TX Dimensions	1-14
1.7	716FX2	1-15
1.7.1	Features and Benefits	1-15
1.7.2	716FX2 Specifications	1-16
1.7.3	716FX2 Dimensions	1-17
1.8	716M12	1-18
1.8.1	Features and Benefits	1-18
1.8.2	716M12 Specifications	1-19
1.8.3	716M12 Dimensions	1-20
1.9	7018TX	1-21
1.9.1	Features and Benefits	1-21
1.9.2	7018TX Specifications	1-22
1.9.3	7018TX Dimensions	1-23
1.10	7018FX2	1-24
1.10.1	Features and Benefits	1-24
1.10.2	7018FX2 Specifications	1-25
1.10.3	7018FX2 Dimensions	1-26
1.11	Transceiver Characteristics	1-27
1.11.1	100 MB Fiber Transceiver Characteristics	1-27
1.11.2	Gigabit Fiber Transceiver (SFP) Characteristics	1-27
1.12	LEDs	1-28
1.13	Ordering Guide	1-29
1.13.1	708TX	1-29
1.13.2	708FX2 / 708FXE2	1-29
1.13.3	716TX	1-30
1.13.4	716FX2	1-31
1.13.5	7018TX	1-32
1.13.6	7018FX2	1-33
1.13.7	708M12	1-34
1.13.8	716M12	1-35
<b>Chapter 2</b>	<b>Hardware Installation</b>	<b>2-37</b>
2.1	Unpacking	2-37
2.2	ATEX Installation Requirements (708 Series Only)	2-37
2.3	Mounting the Unit	2-37





- 2.3.1 DIN-Rail Mounting Instructions for 708TX and 708FX2 Models . . . . . 2-38
  - Vertical Mounting 708TX and 708FX2 . . . . . 2-38
  - Horizontal Mounting 708TX and 708FX2 . . . . . 2-38
- 2.3.2 DIN-Rail Mounting Instructions for 716TX, 716FX2, 7018TX, and 7018FX2 Models . . 2-39
  - Vertical Mounting 716TX, 716FX2, 7018TX, and 7018FX2 . . . . . 2-39
- 2.3.3 DIN-Rail Removal Instructions From Vertical Mounting . . . . . 2-40
- 2.3.4 Bulkhead Mounting 708M12 and 716M12 Models . . . . . 2-40
- 2.3.5 Horizontal DIN-Rail Mounting 708M12 and 716M12. . . . . 2-41
- 2.4 Connect Power Source . . . . . 2-42
  - 2.4.1 708TX, 708FX2, 716TX, 716FX2, 7018TX, and 7018FX2 Models . . . . . 2-42
  - 2.4.2 708M12 and 716M12 Models . . . . . 2-43
- 2.5 Grounding the Switch . . . . . 2-43
  - 2.5.1 Grounding 708TX, 708FX2, 716TX, 716FX2, 7018TX, and 7018FX2 Models . . . . . 2-44
  - 2.5.2 Grounding 708M12 and 716M12 Models . . . . . 2-44
- 2.6 Connecting the Switch . . . . . 2-45
  - 2.6.1 Connecting the 708TX, 708FX2, 716TX, 716FX2, 7018TX, and 7018FX2 Models . . 2-45
    - Connect the Ethernet Cable . . . . . 2-45
    - RJ45 Connector Crimp Specifications . . . . . 2-46
  - 2.6.2 708TX, 708FX2, 716TX, 716FX2, 7018TX, and 7018FX2 Model Serial Interface . . . 2-47
    - Serial Cable Connection . . . . . 2-47
  - 2.6.3 Connecting the 708M12 and 716M12 Models . . . . . 2-47
    - 708M12 and 716M12 Model Serial Interface . . . . . 2-48
    - Serial Cable Connection . . . . . 2-48
  - 2.6.4 Configure the Terminal Interface . . . . . 2-49
- 2.7 700-NTCD-M12 Configuration Device . . . . . 2-49
- 2.8 Cleaning . . . . . 2-49
- 2.9 Troubleshooting . . . . . 2-49

**Chapter 3 Accessing the Web Software Interface . . . . . 3-51**



# Preface

## Disclaimer

Portions of this document are intended solely as an outline of methodologies to be followed during the installation maintenance and operation of N-Tron® Series 700 and 7000 models switches. It is not intended as a step-by-step guide or a complete set of all procedures necessary and sufficient to complete all operations.

While every effort has been made to ensure that this document is complete and accurate at the time of release, the information that it contains is subject to change. Red Lion Controls is not responsible for any additions to or alterations of the original document. Industrial networks vary widely in their configurations, topologies, and traffic conditions. This document is intended as a general guide only. It has not been tested for all possible applications, and it may not be complete or accurate for some situations.

Users of this document are urged to heed warnings and cautions summarized at the front of the document, such as electrical hazard warnings.

## Compliance Information

It is recommended that the owner of this equipment determine and ensure conformance with any specific and applicable local regulations.

### Part 15 of the Federal Communications Commission (FCC) - A Rules: Interference

Every effort has been made to ensure that this equipment is designed to comply with the limits for a Class A digital device, as described in the FCC Rules.

This product complies with Part 15 of the FCC-A Rules.

Operation is subject to the following conditions:

1. This device may not cause harmful Interference
2. This device must accept any interference received, including interference that may cause undesired operation.

**Note** - This equipment has been tested and found to comply with the limits for a Class A digital device, pursuant to Part 15 of the FCC Rules. These limits are designed to provide reasonable protection against harmful interference in a residential installation. This equipment generates, uses, and can radiate radio frequency energy and, if not installed and used in accordance with the instructions, may cause harmful interference to radio communications. Operation of this device in a residential area is likely to cause harmful interference in which case the user will be required to correct the interference at their own expense.

### Déclaration de conformité FCC

Ce produit est conforme à la partie 15 des règles de la FCC -A

Utilisation est soumise aux conditions suivantes:

1. Ce dispositif ne doit pas causer des interférences nuisibles
2. Cet appareil doit accepter toute interférence reçue, y compris les interférences qui peuvent causer un mauvais fonctionnement.



**Note:** Cet équipement a été testé et jugé conforme aux limites de la classe A des appareils numériques, conformément à la partie 15 des règles de la FCC. Ces limites sont conçues pour fournir une protection raisonnable contre les interférences nuisibles dans une installation résidentielle. Cet équipement génère, utilise et peut émettre de l'énergie radiofréquence et, si il n'est pas installé et utilisé conformément aux instructions, peut causer des interférences nuisibles aux communications radio. L'utilisation de cet appareil dans une zone résidentielle est susceptible de provoquer des interférences nuisibles, auquel cas l'utilisateur sera tenu de corriger les interférences à ses propres frais.

### Innovation, Science and Economic Development Canada

This Class A digital apparatus meets all requirements of the CAN ICES-003. Operation is subject to the following two conditions; (1) this device may not cause harmful interference, and (2) this device must accept any interference received, including interference that may cause undesired operation.

Cet appareillage numérique de la classe A répond à toutes les exigences de CAN ICES-003. L'opération est sujette aux deux conditions suivantes: (1) ce dispositif peut ne pas causer l'interférence nocive, et (2) ce dispositif doit accepter n'importe quelle interférence reçue, y compris l'interférence qui peut causer l'opération peu désirée.

### Environmental Impact Statement

Red Lion equipment contains no hazardous materials as defined by the United States Environmental Protection Agency (USEPA). Red Lion recommends that all failed product be returned to Red Lion for failure analysis and proper disposal.

### Toxic Emissions

Red Lion equipment releases no toxic emissions.

### Trademark Acknowledgments

Ethernet™ is a registered trademark of Xerox Corporation.

EtherNet/IP™ and CIP™ are registered trademarks of ODVA™.

All other company and product names are trademarks of their respective owners.

### Release Notes and Document Updates

The hard copy and electronic media versions of this document are revised only at major releases and therefore, may not always contain the latest product information. As needed, Documentation Notes and or Product Bulletins will be provided between major releases to describe any new information or document changes.

The latest online version of this document and all product updates can be accessed through the Red Lion web site at <http://www.redlion.net>

### Publication History

The following information lists the release history of this document.

Issue/Revision	Release Date	Content Description
Initial release	January 2019	Initial document release combining 700/7000 switch models



## Related Documents

This Hardware Manual Volume I covers the following 700/7000 product models:

708TX 708FX2 716TX 716FX2 708M12 716M12 7018TX 7018FX2

Hardware Manual Volume II covers the following 700/7000 models:

709FX 710FX2 711FX3 712FX4 714FX6 7010TX 7012FX2 7026TX 7506GX2 7900

Visit the Technical Resources page on the Red Lion website at the following link to view available documents related to this product.

[www.redlion.net/n-tron\\_documentation](http://www.redlion.net/n-tron_documentation)

## Document Comments

Red Lion appreciates all comments that will help us to improve our documentation quality. The user can submit comments through the Red Lion Customer Service. Simply email us at [support.redlion.net](mailto:support.redlion.net).

## Additional Product Information

Additional product information can be obtained by contacting the local sales representative or Red Lion through the contact numbers and/or e-mail addresses listed on the inside of the front cover.

## Cautions and Warnings / Mises en Garde et Avertissements



Warnings apply to situations where personal injury or death may result.

Mises en garde s'appliquent aux situations où les risques de blessures graves ou mortelles peuvent en résulter.



Cautions apply to where reduced function or damage to equipment may result.

Les mises en garde s'appliquent à où une fonction réduite ou d'endommagement de l'équipement peut entraîner.

### General Safety Cautions and Warnings / Précautions et Avertissements de Sécurité Générale

	<p><b>CAUTION:</b> If the equipment is used in a manner not specified by Red Lion, the protection provided by the equipment may be impaired.</p> <p><b>ATTENTION:</b> Si l'équipement est utilisé d'une manière non spécifiée par Red Lion, la protection fournie par l'équipement peut être compromise.</p>
	<p><b>CAUTION:</b> Do not block any air vents on the unit.</p> <p><b>ATTENTION:</b> N'obstruez pas les fentes d'aération de l'unité.</p>



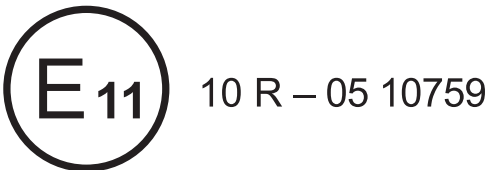

	<p><b>CAUTION:</b> Do not operate the equipment in a manner not specified by this manual. <b>ATTENTION:</b> Ne pas faire fonctionner l'équipement d'une manière non spécifiée par ce manuel.</p>
	<p><b>WARNING:</b> Install only in accordance with Local and National Codes of authorities having jurisdiction. <b>AVERTISSEMENT:</b> Installer uniquement, conformément aux codes locaux et nationaux des autorités ayant compétence.</p>







**E-Mark Type Approved (708TX only)****KC Mark (Korea)**

**Note:** Models 708TX, 708FX(E)2, 716TX, 716FX(E)2, 7018TX and 7018FX(E)2 only

<p><b>A 급 기기</b> (업무용 방송통신 기자재) <b>Class A device</b> (Broad-casting and communication equipments for office work)</p>	<p>이기는 업무용(A급) 전자파 적합기기로서 판매자 또는 사용자는 이 점을 주의하시기 바라며, 가정 외 지역에서 사용하는 것을 목적으로 합니다. This equipment is office use (Class A) electromagnetic wave suitability equipment and seller or user should take notice of it, and this equipment is to be used in the places except for home.</p>
--	--

**Electrical Safety Warnings / Avertissements de Sécurité Électrique**

	<p><b>WARNING -</b> Never install or work on electrical equipment or cabling during periods of lightning activity. <b>AVERTISSEMENT -</b> Ne jamais installer ou travailler sur équipement électrique ou de câblage pendant les périodes d'activité de la foudre.</p>
	<p><b>CAUTION:</b> Do not perform any services on the unit unless qualified to do so. Do not substitute unauthorized parts or make unauthorized modifications to the unit. <b>ATTENTION:</b> Ne pas effectuer de services sur l'appareil s'il n'est pas qualifié pour le faire. Ne pas substituer pièces non autorisées ou de modifications non autorisées de l'appareil.</p>

	<p>WARNING: Properly ground the unit before connecting anything else to the unit. Units not properly grounded may result in a safety risk and could be hazardous and may void the warranty. See the grounding technique section of this manual for proper ways to ground the unit.</p> <p>AVERTISSEMENT: L'unité doit être correctement mise à la terre avant tout raccordement à l'unité. Unités pas correctement mise à la terre peuvent causer un risque de sécurité et pourraient être dangereuses et peuvent annuler la garantie. Voir la section technique de mise à la terre dans ce mode d'emploi pour des moyens appropriés à la masse de l'appareil.</p>
	<p>WARNING: Models 716TX, 716FX(E)2, 7018TX and 7018FX(E)2 must be used with a Listed UL Class 2 Industrial Power Supply.</p> <p>AVERTISSEMENT: Modèles 716TX, 716FX(E)2, 7018TX et 7018FX(E)2 doit être utilisé avec une Classe UL 2 alimentation industrielle.</p>
	<p>WARNING: (Models 708M12 and 716M12) for redundant applications both inputs must be provided from the same Class 2 source.</p> <p>AVERTISSEMENT: (Modèles 708M12 et 716M12) pour applications redondantes les deux entrées doivent être fournis à partir de la même source de classe 2.</p>
	<p>WARNING: Do not service the equipment without first disconnecting the power connector.</p> <p>AVERTISSEMENT: Ne pas effectuer l'entretien de l'équipement sans avoir préalablement débranché le connecteur d'alimentation.</p>
	<p>WARNING - Do not operate the unit with any cover removed, as this could create a shock or fire hazard.</p> <p>AVERTISSEMENT - Ne pas faire fonctionner l'unité avec un capot enlevé, car cela pourrait créer une décharge électrique ou un incendie.</p>
	<p>CAUTION: Observe proper DC Voltage polarity when installing power input cables. Reversing voltage polarity can cause permanent damage to the unit and void the warranty.</p> <p>ATTENTION: Respectez la polarité correcte de tension DC lors de l'installation des câbles d'alimentation d'entrée. Inversion de polarité de tension peut causer des dommages permanents à l'appareil et annule la garantie.</p>

### Environmental Safety Cautions and Warnings / Sécurité Environnementale Mises en Garde et Avertissements

	<p>WARNING: Do not operate the equipment in the presence of flammable gases or fumes. Operating electrical equipment in such an environment constitutes a definite safety hazard.</p> <p>AVERTISSEMENT : Ne pas utiliser le matériel en présence de gaz ou de vapeurs inflammables. L'utilisation de matériel électrique dans un tel environnement constitue un danger certain.</p>
---	---

	<p><b>WARNING:</b> Disconnect the power and allow to cool 5 minutes before touching.</p> <p><b>AVERTISSEMENT:</b> Déconnectez le câble d'alimentation et laissez refroidir 5 minutes avant de la toucher.</p>
---	---

### Hazardous Location Warnings / Les Avertissements d'Emplacement Dangereux

	<p><b>CAUTION:</b> This equipment is suitable for use in Class I, Division 2, Groups A, B, C, and D or non-hazardous locations only. Combinations of equipment in your system are subject to investigation by the local authority having jurisdiction at the time of installation.</p> <p><b>ATTENTION:</b> Cet appareil est adapté pour utilisation en Classe I, Division 2, Groupes A, B, C, D ou endroits non-dangereux seulement. Combinaisons d'équipements de votre système sont objet d'une enquête par l'autorité locale compétente au moment de l'installation.</p>
---	--



	<p><b>WARNING:</b> Do not remove or replace Ethernet and plug-in optical transceiver connections while circuit is live unless the area is known to be free of ignitable concentrations of flammable substances. Marking shall be displayed in a prominent place on the end-enclosure.</p> <p><b>AVERTISSEMENT:</b> Ne pas enlever ou remplacer l'Ethernet et l'émetteur-récepteur optique plug-in tout en circuit est vivre à moins que la région est connue pour être à l'abri de des concentrations de substances inflammables. Le marquage doit être affichée dans un endroit bien en vue sur l'enceinte.</p>
---	--

	<p><b>WARNING - Explosion Hazard –</b> Substitution of components may impair suitability for Class I, Division 2.</p> <p><b>AVERTISSEMENT - Risque d'explosion -</b> La substitution de tout composant peut nuire à la conformité de Classe 1, Division 2.</p>
--	--

	<p><b>WARNING – Explosion Hazard –</b> Do not connect or disconnect any connections while circuit is live unless area is known to be non-hazardous.</p> <p><b>AVERTISSEMENT - Risque d'explosion -</b> Ne pas brancher ou débrancher les connexions lorsque le circuit est sous tension sauf si la zone est connue pour être non dangereux.</p>
---	---

	<p><b>WARNING:</b> (Models 716TX, 716FX(E)2, 7018TX and 7018FX(E)2) Exposure to some chemicals may degrade the sealing properties of materials used in the Sealed Relay Device U25. Additionally, substitution of U25 may impair suitability for Division 2.</p> <p><b>AVERTISSEMENT:</b> (Modèles 716TX, 716FX(E)2, 7018TX et 7018FX(E)2) L'exposition à certains produits chimiques risquent de dégrader l'étanchéité des propriétés des matériaux utilisés dans l'appareil relais étanche U25. En outre, la substitution de U25 peut nuire à la conformité de la Division 2.</p>
---	---

	<p><b>WARNING – Explosion Hazard –</b> Do not replace the device unless power has been switched off or the area is known to be non-hazardous.</p> <p><b>AVERTISSEMENT – Risque d'explosion -</b> Ne pas remplacer l'appareil à moins que l'alimentation a été coupée ou que la zone est connue pour être non-dangereuse.</p>
---	--

	<p>WARNING: Disconnect the power cable before removing any enclosure panel. AVERTISSEMENT: Débrancher le câble d'alimentation avant de retirer tout panneau de boîtier.</p>
	<p>WARNING: Use 60/75°C rated Copper wire for models 708TX, 708FX(E)2, and 90°C or higher for models 716TX, 716FX(E)2, 7018TX, 7018FX(E)2, and 110°C or higher for models 708M12, and 716M12. All use (0.22Nm) 2lb/in tightening torque for field installed conductors. AVERTISSEMENT: Utilisez 60/75°C le fil de cuivre pour les modèles 708TX, 708FX(E)2 et 90°C ou plus pour les modèles 716TX, 716FX(E)2, 7018TX, 7018FX(E)2, et 110°C ou plus pour les modèles 708M12 et 716M12. Toute utilisation (0,22 Nm) 2lb/dans le couple de conducteurs installés sur le terrain.</p>

### Laser Safety Warnings / Avertissements de Sécurité Laser



	<p>CAUTION: CLASS 1 LASER PRODUCT. Do not stare into the laser. ATTENTION: PRODUIT LASER CLASSE 1. Ne pas regarder dans le laser.</p>
---	---

**Note:** Laser safety must be observed with the following models having lasers present: 708FXE2 Models -40, -80; 716FXE2 Models -40, -80; 7018FXE2 Models -40, -80 and optionally NTSFP-LX -40 and -80.

**Remarque:** Sécurité laser doit être observé avec les modèles suivants ayant lasers présents: 708FXE2 Modèles -40, -80; 716FXE2 modèles -40, -80; 7018FXE2 Modèles -40, -80 et éventuellement NTSFP-LX -40 et -80.



## Regulatory Certifications and Approvals

Specification/Model	708TX	708FX2	708M12	708M12 -HV	716TX	716TX -HV	716FX2	716FX2 -HV	716M12	716M12 -HV	7018TX	7018TX -HV	7018FX2	7018FX2 -HV
<b>Product Safety</b>														
UL 508, ANSI/ISA-12.12.01, Nonincendive Electrical Equipment for Use in Class I and II, Division 2 and Class III, Division 1 and 2 Hazardous (Classified) Locations, or Non-Hazardous Locations Only	x	x	x		x		x		x		x		x	
CAN/CSA-C22.2 No. 14-13, Industrial Control Equipment; CAN/CSA-C22.2 NO. 213M1987, Non-incendive Electrical Equipment for Use in Class I, Division 2 Hazardous Locations	x	x	x		x		x		x		x		x	
 II 3 G Ex nA nC IIC Gc DEMKO 03 ATEX 0316686U	x	x			x		x				x		x	
 II 3 G Ex nA IIC Gc DEMKO 03 ATEX 0316686U			x						x					
TUV/GS EN 60950-1, AfPS GS 2014				x		x		x		x		x		x
<b>EMI</b>														
ANSI C63.4, FCC 47 CFR Part 15, Subpart B - Class A, ICES-003	x	x	x	x	x	x	x	x	x	x	x	x	x	x
EN 61000-6-4 (Emissions)			x	x					x	x				
EN 61000-3-2/3 (Emissions)									x	x				
EN 55011 Class A (Emissions)	x	x		x					x	x				
<b>EMC</b>														
EN 61000-6-2 (Immunity)	x	x	x	x	x	x	x	x	x	x	x	x	x	x
EN/IEC 61000-4-2 (ESD)	x	x	x	x	x	x	x	x	x	x	x	x	x	x
EN/IEC 61000-4-3 (RFI)	x	x	x	x	x	x	x	x	x	x	x	x	x	x
EN/IEC 61000-4-4 (EFT)	x	x	x	x	x	x	x	x	x	x	x	x	x	x
EN/IEC 61000-4-5 (Surge)	x	x	x	x	x	x	x	x	x	x	x	x	x	x
EN/IEC 61000-4-6 (RF)	x	x	x	x	x	x	x	x	x	x	x	x	x	x
EN/IEC 61000-4-8 (PF)	x	x		x	x	x	x	x	x	x	x	x	x	x
EN/IEC 61000-4-11 (Voltage Dips)	x	x		x	x	x	x	x	x	x	x	x	x	x
<b>Environmental</b>														
Designed to comply with IEEE 1613 Electric Utility Substations	x	x	x	x	x	x	x	x	x	x	x	x	x	x
Designed to comply with NEMA TS1/TS2 Traffic Control	x	x	x	x	x	x	x	x	x	x	x	x	x	x



Specification/Model	708TX	708FX2	708M12	708M12 -HV	716TX	716TX -HV	716FX2	716FX2 -HV	716M12	716M12 -HV	7018TX	7018TX -HV	7018FX2	7018FX2 -HV
<b>Other</b>														
ABS (PDA and Type Approval for Shipboard Applications)	x	x	x						x					
EMC Directive 2014/30/EU	x	x	x	x	x	x	x	x	x	x	x	x	x	x
Low Voltage Directive 2014/35/EU	x	x	x	x	x	x	x	x	x	x	x	x	x	x
DNV GL Type Approval Certification	x	x	x											
RoHS 2 Directive 2011/65/EU	x	x	x	x	x	x	x	x	x	x	x	x	x	x
RoHS 3 Directive (EU) 2015/863/*	x	x	x	x	x	x	x	x	x	x	x	x	x	x

\* Effective 22 July 2019



# Chapter 1 Product Overview

## 1.1 Common Features

Red Lion's N-Tron<sup>®</sup> series 700/7000 managed Industrial Gigabit Ethernet switches offer a wide array of port configurations and media types. See [“Available Models”](#) for a list of the 700/7000 models covered in this document. Refer to N-Tron<sup>®</sup> Series 700/7000 Managed Industrial Gigabit Ethernet Switch, Volume II LP0988 for other available 700/7000 models.

All 700/7000 switches offer plug-and-play installation with IGMP support, media/port auto-detection and simple ring configuration, making the 700/7000 platform one of the easiest to deploy managed industrial Ethernet switches in the industry. Housed in rugged hardened enclosures, the 700/7000 switches feature extended shock and vibration specifications, wide operating temperature ratings and best-in-class ring technology.

### 1.1.1 Connectivity

The 700/7000 fully managed Ethernet switch models offer a wide array of port configurations and media types with 10/100 copper, as well as Fast Ethernet and Gigabit fiber options.

### 1.1.2 Performance

700/7000 managed switches provide uncompromising performance in harsh environments. Network management features like N-Ring<sup>™</sup>, VLAN, Quality of Service (QoS), port mirroring, IGMP, and SNMP provide best-in-class visibility, security and uptime performance. Please see the 700/7000 Software Manual, document LP0985, for more information.

### 1.1.3 Environmental

The ultra-reliable 700/7000 fully managed industrial Ethernet switches are DIN-Rail mountable and offer operating temperatures up to -40 °C to 85 °C. With UL Class I, Division 2 listing, and CE certifications, these industrial switches are built to last in the most demanding environments. Additionally, the 708M12 and 716M12 are IP67 rated for protection against dust, low and high pressure water jets and temporary immersion in water.

### 1.1.4 Monitoring

The N-View<sup>™</sup> monitoring technology provided with the switch provides up to 47 different status points on switch and port conditions and displays that information on a networked computer.

### 1.1.5 Security

The 700/7000 managed industrial Ethernet switches provide a high level of security utilizing port-based MAC address filtering and SNMPv3 communication protocol to ensure safe connections.



## 1.2 Available Models

Model	Total Ports	Mounting	Operating Temperature	10/100 TX RJ45 Copper Ports	100 FX Ports	SFPs***	Redundant Power Input	HV Option Power Input
708TX	8	DIN-Rail	-40 °C to 85 °C	8	-	-	10-30 VDC	-
708FX2	8	DIN-Rail	-40 °C to 85 °C	6	2	-	10-30 VDC	-
708M12	8	Bulkhead DIN-Rail*	-40 °C to 80 °C	8**	-	-	10-30 VDC	40-160 VDC*
716TX	16	DIN-Rail	-40 °C to 70 °C	16	-	-	10-30 VDC	40-160 VDC*
716FX2	16	DIN-Rail	-40 °C to 70 °C	14	2	-	10-30 VDC	40-160 VDC*
716M12	16	Bulkhead DIN-Rail*	-40 °C to 85 °C	16**	-	-	10-49 VDC	40-160 VDC*
7018TX	18	DIN-Rail	-40 °C to 70 °C	16	-	Up to 2*	10-30 VDC	40-160 VDC*
7018FX2	18	DIN-Rail	-40 °C to 70 °C	14	2	Up to 2*	10-30 VDC	40-160 VDC*

\* Optional

\*\* M12 D-Coded Ports

\*\*\* See [“Gigabit Fiber Transceiver \(SFP\) Characteristics”](#) on page 27 for available Gigabit SFP transceivers.

## 1.3 708TX

The versatile 708TX Industrial Ethernet managed switch features eight 10/100 BaseTX RJ45 copper ports housed in a hardened metal DIN-Rail enclosure with redundant 10-30 VDC power inputs. Designed to handle the most demanding environments, the 708TX offers expanded shock and vibration ratings and wide -40 °C to 85 °C operating temperature rating. The 708TX combines outstanding performance and ease of use. The fully managed switch is ideally suited for connecting Ethernet-enabled industrial and/or security equipment.

### 1.3.1 Features and Benefits

#### Features and Benefits

Full IEEE 802.3 Compliance  
 Eight 10/100 Base-T(X) RJ45 Copper Ports  
 Redundant 10 to 30 VDC Power Inputs

- Keeps network running in the event of a power supply failure.

-40 °C to 85 °C operating temperature  
 ESD and Surge Protection Diodes on all Ports  
 Autosensing 10/100BaseTX, Duplex, and MDIX  
 Offers Rapid Spanning Tree Protocol  
 Trunk with other N-Tron trunking capable switches over two ports  
 Store & Forward Technology  
 Plug-and-Play IGMP Support  
 Rugged DIN-Rail Enclosure  
 SNMP v1, v2 and v3  
 Web Browsing and N-View Switch Monitoring  
 Configurable Alarm Contact  
 Configurable Bi-Color Fault Status LED

#### Fully Managed Features Include:

- Full SNMP and Web Browser Management
- Detailed Ring Map and Fault Location Charting
- IGMP
- N-Ring™ Technology with ~30ms Healing
- N-Link™ Redundant Ring Technology
- N-View™ OPC Monitoring
- 802.1Q VLAN Tagging and Port VLAN
- 802.1p QoS and Port QoS
- 802.1d, 802.1w, 802.1D RSTP (Rapid Spanning Tree)
- Ethernet/IP™ CIP Messaging
- LLDP (Link Layer Discovery Protocol)
- Trunking and Port Mirroring
- DHCP Client Server, Option 82 relay, Option 61, IP Fallback
- Local Port IP Addressing
- Port Security-MAC Address Based



### 1.3.2 708TX Specifications

Mechanical				
Height	Width	Depth	Weight	Mount
2.27" (5.8 cm)	6.0" (15.3 cm)	3.75" (9.6 cm)	1.7 lbs (0.8 kg)	35mm DIN-Rail
Power Input				
Input Voltage	Steady Input Current	Inrush Current	BTU/hr	
10-30 VDC (Regulated)	250 mA @ 24 VDC	11.8 A /0.1 ms @ 24 VDC	20.5 @ 24 VDC	
Environmental				
Operating Temperature	Storage Temperature	Operating Humidity		Operating Altitude
-40 °C to 85 °C	-40 °C to 85 °C	5% to 95% (non condensing)		0 to 10,000 ft.
Shock and Vibration				
Shock	Vibration		Note	
200g @ 10 ms	50g, 5-200Hz, Triaxial		Unit must be bulkhead mounted to achieve these levels.	
Connectors				
10/100BaseTX: Eight RJ45 copper ports				
Recommended Minimum Wiring Clearance				
Top	1" (2.54 cm)			
Front	2" (5.08 cm)			
Network Media				
10BaseT	100BaseTX			
≥CAT3 Cable	≥CAT5 Cable			
Switch Properties				
Number of MAC Addresses		Aging Time	Latency (Typical)	Switching Method
8,000		Programmable	2.6 μs	Store & Forward



### 1.3.3 708TX Dimensions

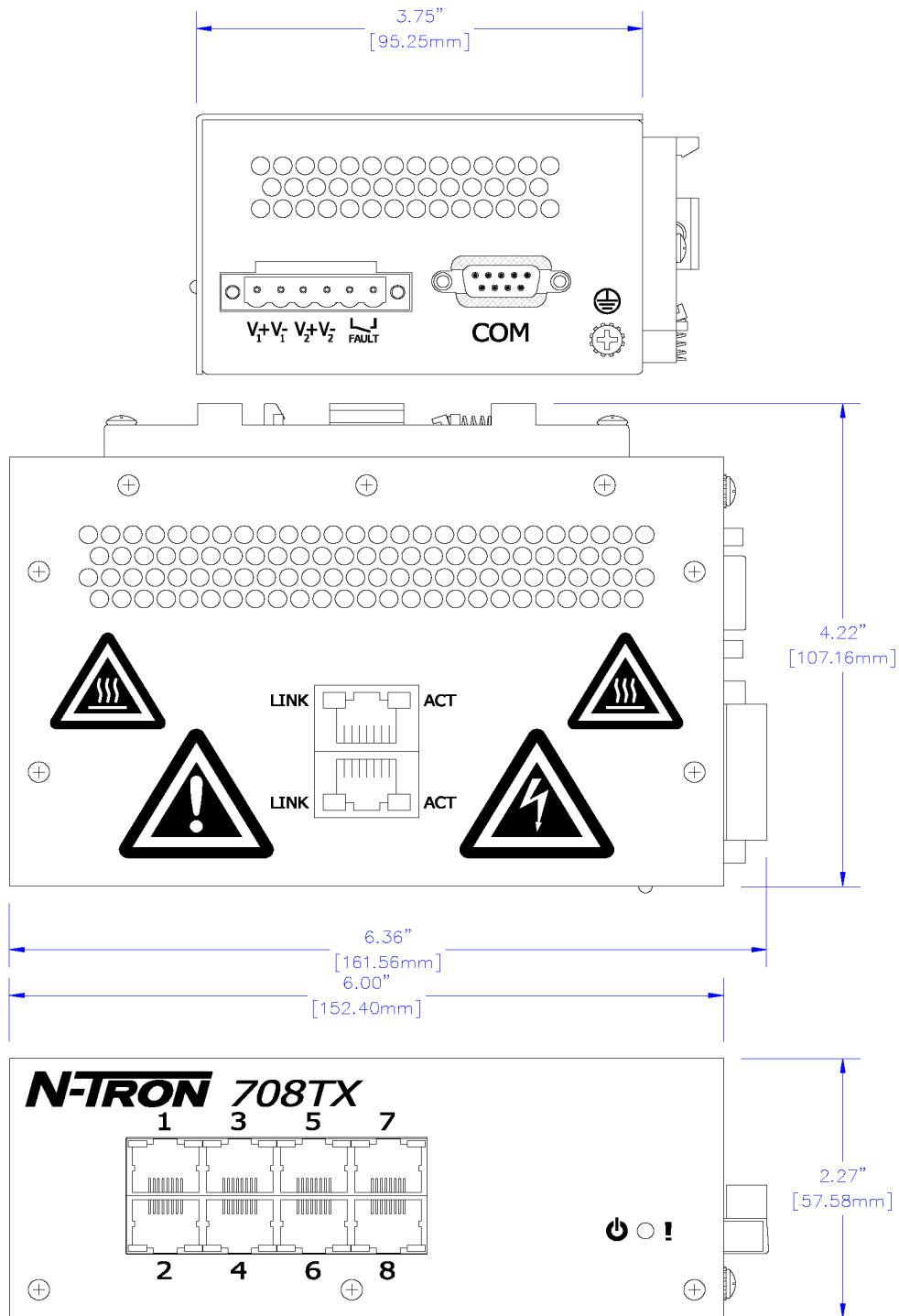

All specifications are subject to change. Consult the company website for more information.



## 1.4 708FX2

The versatile 708FX2 Industrial Ethernet managed switch features six 10/100 BaseTX RJ45 copper ports and two 100Base ST or SC fiber ports housed in a hardened metal DIN-Rail enclosure with redundant 10-30 VDC power inputs. Designed to handle the most demanding environments, the 708FX2 offers expanded shock and vibration ratings and wide -40 °C to 85 °C operating temperature rating. The 708FX2 combines outstanding performance and ease of use. The fully managed switch is ideally suited for connecting Ethernet-enabled industrial and/or security equipment.

### 1.4.1 Features and Benefits

#### Features and Benefits

Full IEEE 802.3 Compliance  
Six 10/100 Base-T(X) RJ45 Copper Ports  
Two 100BaseFX Fiber Ports, ST or SC  
Redundant 10 to 30 VDC Power Inputs

- Keeps network running in the event of a power supply failure.

-40 °C to 85 °C operating temperature  
ESD and Surge Protection Diodes on all Ports  
Autosensing 10/100BaseTX, Duplex, and MDIX  
Offers Rapid Spanning Tree Protocol  
Trunk with other N-Tron trunking capable switches over two ports  
Store & Forward Technology  
Plug-and-Play IGMP Support  
Rugged DIN-Rail Enclosure  
SNMP v1, v2 and v3  
Web Browsing and N-View Switch Monitoring  
Configurable Alarm Contact  
Configurable Bi-Color Fault Status LED

#### Fully Managed Features Include:

- Full SNMP and Web Browser Management
- Detailed Ring Map and Fault Location Charting
- IGMP
- N-Ring™ Technology with ~30ms Healing
- N-Link™ Redundant Ring Technology
- N-View™ OPC Monitoring
- 802.1Q VLAN Tagging and Port VLAN
- 802.1p QoS and Port QoS
- 802.1d, 802.1w, 802.1D RSTP (Rapid Spanning Tree)
- Ethernet/IP™ CIP Messaging
- LLDP (Link Layer Discovery Protocol)
- Trunking and Port Mirroring
- DHCP Client, Server, Option 82 relay, Option 61 and IP Fallback
- Local Port IP Addressing
- Port Security-MAC Address Based





### 1.4.2 708FX2 Specifications

Mechanical				
Height	Width	Depth	Weight	Mount
2.27" (5.8 cm)	6.0" (15.3 cm)	4.70" (11.94 cm)	1.7 lbs (0.8 kg)	35mm DIN-Rail
Power Input				
Input Voltage	Steady Input Current	Inrush Current	BTU/hr	
10-30 VDC (Regulated)	330 mA @ 24 VDC	11.8 A /0.1 ms @ 24 VDC	27 @ 24 VDC	
Environmental				
Operating Temperature	Storage Temperature	Operating Humidity		Operating Altitude
-40 °C to 85 °C	-40 °C to 85 °C	5% to 95% (non condensing)		0 to 10,000 ft.
Shock and Vibration				
Shock	Vibration		Note	
200g @ 10ms	50g, 5-200Hz, Triaxial		Unit must be bulkhead mounted to achieve these levels.	
Connectors				
10/100BaseTX: Six RJ45 copper ports 100BaseFX: Two SC or ST duplex fiber ports				
Recommended Minimum Wiring Clearance				
Top	1" (2.54 cm)			
Front	4" (10.16 cm)			
Network Media				
10BaseT	100BaseTX	100BaseFX	100BaseFXE	
≥CAT3 Cable	≥CAT5 Cable	Multimode: 50-62.5/125µm	Singlemode: 7-10/125µm	
Switch Properties				
Number of MAC Addresses		Aging Time	Latency (Typical)	Switching Method
8,000		Programmable	2.6 µs	Store & Forward

Refer to ["100 MB Fiber Transceiver Characteristics"](#)



### 1.4.3 708FX2 Dimensions

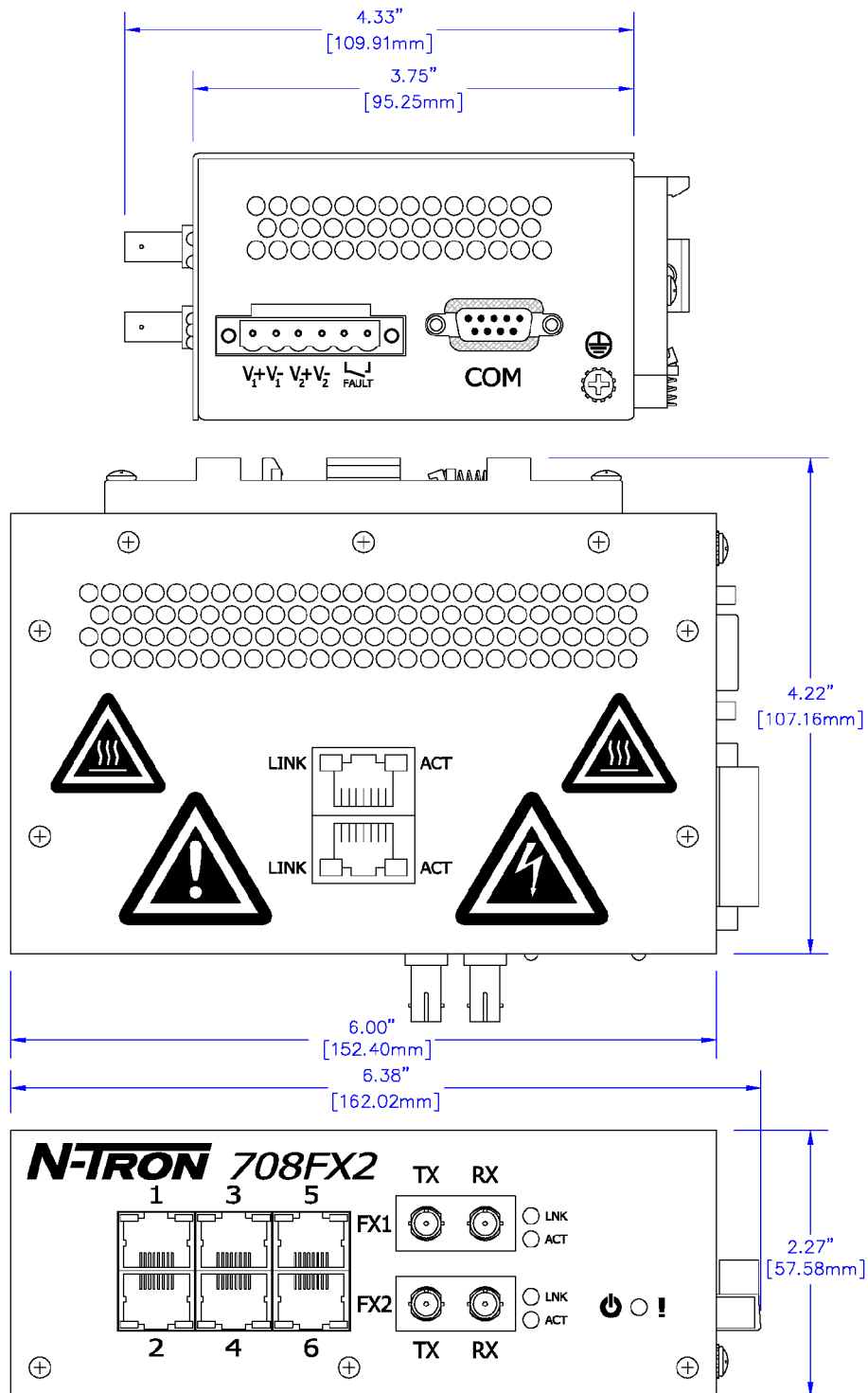

All specifications are subject to change. Consult the company website for more information.



## 1.5 708M12

The versatile 708M12 Industrial Ethernet managed switch features eight 10/100 BaseTX M12 D-coded copper ports and redundant 10-30 VDC power inputs (HV 40-160 VDC available). Designed to handle the most demanding environments with IP rated protection against exposure to low/high pressure water jets and protection against temporary immersion in water.

### 1.5.1 Features and Benefits

#### Features and Benefits

Full IEEE 802.3 Compliance  
Eight 10/100 Base-TX M12 D-Coded Ports  
Redundant 10 to 30 VDC Power Inputs

- Keeps network running in the event of a power supply failure.
- –HV High Voltage Option (40-160VDC)

-40 °C to 80 °C operating temperature  
ESD and Surge Protection Diodes on all Ports  
IP65 Rated for protection against low pressure jets of water from any direction  
IP66 Rated for protection against high pressure jets of water from any direction  
IP67 Rated for protection against temporary immersion in water  
IP67 Rated Hardened Metal Enclosure  
Autosensing 10/100BaseTX, Duplex, and MDIX  
Offers Rapid Spanning Tree Protocol  
Trunk with other N-Tron trunking capable switches over two ports  
Store & Forward Technology  
Plug-and-Play IGMP Support  
Rugged DIN-Rail Mounting (optional)  
SNMP v1, v2 and v3  
Web Browsing and N-View Switch Monitoring  
Configurable Bi-Color Fault Status LED

#### Fully Managed Features Include:

- Full SNMP and Web Browser Management
- Configuration Backup via Optional Configuration Device (700-NTCD-M12)
- Detailed Ring Map and Fault Location Charting
- IGMP
- N-Ring™ Technology with ~30ms Healing
- N-Link™ Redundant Ring Technology
- N-View™ OPC Monitoring
- 802.1Q VLAN Tagging and Port VLAN
- 802.1p QoS and Port QoS
- 802.1d, 802.1w, 802.1D RSTP (Rapid Spanning Tree)
- Ethernet/IP™ CIP Messaging
- LLDP (Link Layer Discovery Protocol)
- Trunking and Port Mirroring
- DHCP Client, Server, Option 82 relay, Option 61, and IP Fallback
- Local Port IP Addressing
- Port Security-MAC Address Based

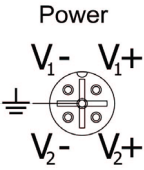
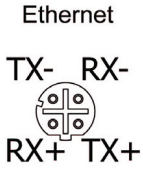

### 1.5.2 708M12 Specifications

Mechanical				
Height	Width	Depth	Weight	Mount
6.7" (16.9 cm)	6.7" (16.9 cm)	1.8" (4.6 cm)	3.4 lbs (1.6 kg)	35mm DIN-Rail (Optional)
Power Input				
Input Voltage	Steady Input Current	Inrush Current	BTU/hr	
10-30 VDC (Regulated)	250 mA @ 24 VDC	15.0 A /1.0 ms @ 24 VDC	20.5 @ 24 VDC	
40-160 VDC (Regulated)*	62 mA @ 124 VDC*		26.4 @ 124 VDC*	
Environmental				
Operating Temperature	Storage Temperature	Operating Humidity		Operating Altitude
-40 °C to 80 °C	-40 °C to 85 °C	5% to 100% (non condensing)		0 to 10,000 ft.
Shock and Vibration				
Shock	Vibration		Note	
200g @ 10 ms	50g, 5-200Hz, Triaxial		Unit must be bulkhead mounted to achieve these levels.	
Connectors				
10/100BaseTX: Eight M12 D Coded Female Copper Ports			POWER: One M12 A Coded Male Port	
COM: One M12 A Coded Female CLI Port			NTCD-M12: One M12 A Coded Female Configuration Device Port	
Pin Assignments				
Power 			Ethernet 	
Recommended Minimum Wiring Clearance				
Front	4" (10.16 cm)			
Network Media				
10BaseT	100BaseTX			
≥CAT3 Cable	≥CAT5 Cable			
Switch Properties				
Number of MAC Addresses	Ageing Time	Latency (Typical)	Switching Method	
8,000	Programmable	2.9 μs	Store & Forward	

\* High Voltage - HV option



### 1.5.3 708M12 Dimensions

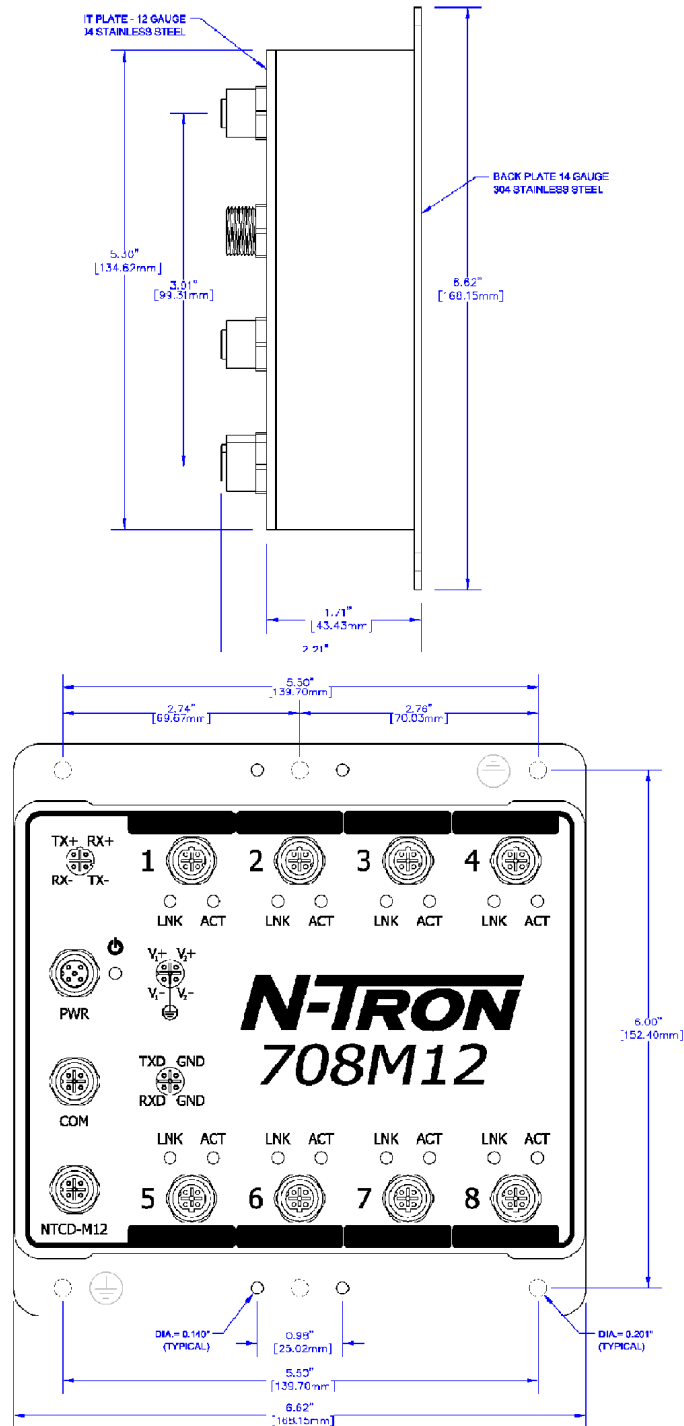

All specifications are subject to change. Consult the company website for more information.



# 1.6 716TX

The versatile 716TX Industrial Ethernet managed switch features 16 10/100 BaseTX RJ45 copper ports housed in a hardened metal DIN-Rail enclosure with redundant 10-30 VDC power inputs (HV 40-160 VDC available). Designed to handle the most demanding environments, the 716TX offers expanded shock and vibration ratings and wide -40 °C to 70 °C operating temperature rating. The 716TX combines outstanding performance and ease of use. The fully managed switch is ideally suited for connecting Ethernet-enabled industrial and/or security equipment.

## 1.6.1 Features and Benefits

### Features and Benefits

Full IEEE 802.3 Compliance  
16 10/100 Base-T(X) RJ45 Copper Ports  
Redundant 10 to 30 VDC Power Inputs

- Keeps network running in the event of a power supply failure.
- -HV High Voltage Option (40-160VDC)

-40 °C to 70 °C operating temperature  
ESD and Surge Protection Diodes on all Ports  
Autosensing 10/100BaseTX, Duplex, and MDIX  
Offers Rapid Spanning Tree Protocol  
Trunk with other N-Tron trunking capable switches over two ports  
Store & Forward Technology  
Plug-and-Play IGMP Support  
Rugged DIN-Rail Enclosure  
SNMP v1, v2 and v3  
Web Browsing and N-View Switch Monitoring  
Configurable Alarm Contact  
Configurable Bi-Color Fault Status LED

### Fully Managed Features Include:

- Full SNMP and Web Browser Management
- Detailed Ring Map and Fault Location Charting
- IGMP
- N-Ring™ Technology with ~30ms Healing
- N-Link™ Redundant Ring Technology
- N-View™ OPC Monitoring
- 802.1Q VLAN Tagging and Port VLAN
- 802.1p QoS and Port QoS
- 802.1d, 802.1w, 802.1D RSTP (Rapid Spanning Tree)
- Ethernet/IP™ CIP Messaging
- LLDP (Link Layer Discovery Protocol)
- Trunking and Port Mirroring
- DHCP Client, Server, Option 82 relay, Option 61, and IP Fallback
- Local Port IP Addressing
- Port Security-MAC Address Based



## 1.6.2 716TX Specifications

Mechanical				
Height	Width	Depth	Weight	Mount
2.27" (5.8 cm)	8.25" (20.95 cm)	4.75" (12.06 cm)	3.3 lbs (1.49 kg)	35mm DIN-Rail
Power Input				
Input Voltage	Steady Input Current	BTU/hr		
10-30 VDC (Regulated)	620 mA @ 24 VDC	50.8 @ 24 VDC		
40-160 VDC (Regulated)*	160 mA @ 124 VDC*	67.7 @ 124 VDC*		
Environmental				
Operating Temperature	Storage Temperature	Operating Humidity		Operating Altitude
-40 °C to 70 °C	-40 °C to 85 °C	5% to 95% (non condensing)		0 to 10,000 ft.
Shock and Vibration				
Shock	Vibration		Note	
200g @ 10ms	50g, 5-200Hz, Triaxial		Unit must be bulkhead mounted to achieve these levels.	
Connectors				
10/100BaseTX: 16 RJ45 copper ports				
Recommended Minimum Wiring Clearance				
Top	1" (2.54 cm)			
Front	2" (5.08 cm)			
Network Media				
10BaseT	100BaseTX			
≥CAT3 Cable	≥CAT5 Cable			
Switch Properties				
Number of MAC Addresses		Aging Time	Latency (Typical)	Switching Method
8,000		Programmable	2.6 μs	Store & Forward

\* High Voltage - HV option



### 1.6.3 716TX Dimensions

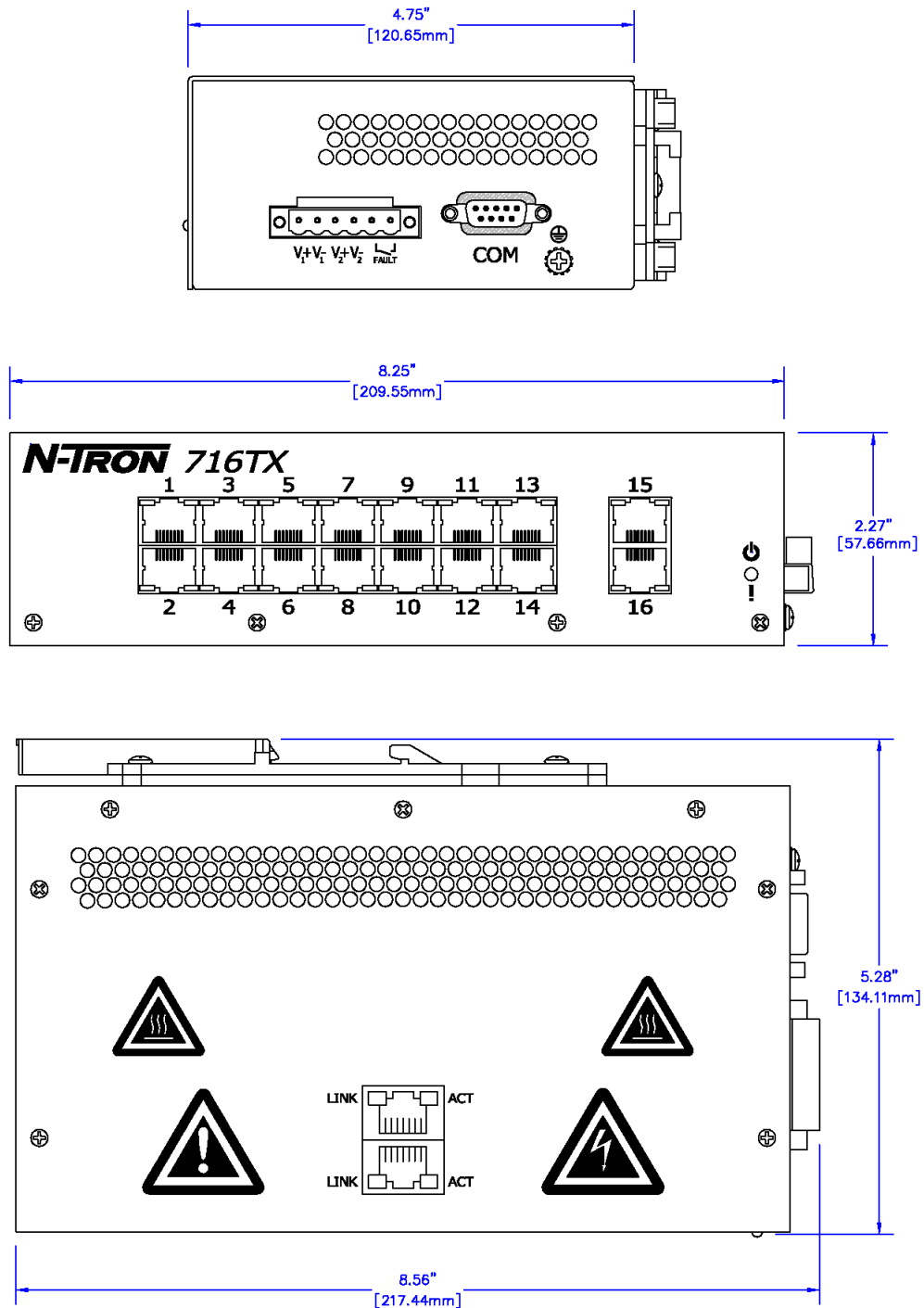

All specifications are subject to change. Consult the company website for more information.





## 1.7 716FX2

The versatile 716FX2 Industrial Ethernet managed switch features 14 10/100 BaseTX RJ45 copper ports and two 100Base ST or SC fiber ports housed in a hardened metal DIN-Rail enclosure with redundant 10-30 VDC power inputs (HV 40-160 VDC available). Designed to handle the most demanding environments the 716FX2 offers expanded shock and vibration ratings and wide -40 °C to 70 °C operating temperature rating. The 716FX2 combines outstanding performance and ease of use. The fully managed switch is ideally suited for connecting Ethernet-enabled industrial and/or security equipment.

### 1.7.1 Features and Benefits

#### Features and Benefits

Full IEEE 802.3 Compliance  
 14 10/100 Base-T(X) RJ45 Copper Ports  
 Two 100BaseFX Fiber Ports, ST or SC  
 Redundant 10 to 30 VDC Power Inputs

- Keeps network running in the event of a power supply failure.
- -HV High Voltage Option (40-160VDC)

-40 °C to 70 °C operating temperature  
 ESD and Surge Protection Diodes on all Ports  
 Autosensing 10/100BaseTX, Duplex, and MDIX  
 Offers Rapid Spanning Tree Protocol  
 Trunk with other N-Tron trunking capable switches over two ports  
 Store & Forward Technology  
 Plug-and-Play IGMP Support  
 Rugged DIN-Rail Enclosure  
 SNMP v1, v2 and v3  
 Web Browsing and N-View Switch Monitoring  
 Configurable Alarm Contact  
 Configurable Bi-Color Fault Status LED

#### Fully Managed Features Include:

- Full SNMP and Web Browser Management
- Detailed Ring Map and Fault Location Charting
- IGMP Auto Configuration
- N-Ring™ Technology with ~30ms Healing
- N-Link™ Redundant Ring Technology
- N-View™ OPC Monitoring
- 802.1Q VLAN Tagging and Port VLAN
- 802.1p QoS and Port QoS
- 802.1d, 802.1w, 802.1D RSTP (Rapid Spanning Tree)
- Ethernet/IP™ CIP Messaging
- LLDP (Link Layer Discovery Protocol)
- Trunking and Port Mirroring
- DHCP Client, Server, Option 82 relay, Option 61, and IP Fallback
- Local Port IP Addressing
- Port Security-MAC Address Based



### 1.7.2 716FX2 Specifications

Mechanical				
Height	Width	Depth	Weight	Mount
2.27" (5.8 cm)	8.25" (20.95 cm)	5.85" (14.86 cm)	3.3 lbs (1.49 kg)	35mm DIN-Rail
Power Input				
Input Voltage	Steady Input Current	BTU/hr		
10-30 VDC (Regulated)	620 mA @ 24 VDC	50.8 @ 24 VDC		
40-160 VDC (Regulated)*	160 mA @ 124 VDC*	67.7 @ 124 VDC*		
Environmental				
Operating Temperature	Storage Temperature	Operating Humidity		Operating Altitude
-40 °C to 70 °C	-40 °C to 85 °C	5% to 95% (non condensing)		0 to 10,000 ft.
Shock and Vibration				
Shock	Vibration		Note	
200g @ 10ms	50g, 5-200Hz, Triaxial		Unit must be bulkhead mounted to achieve these levels.	
Connectors				
10/100BaseTX: 14 RJ45 copper ports 100BaseFX: Two SC or ST duplex fiber ports				
Recommended Minimum Wiring Clearance				
Top	1" (2.54 cm)			
Front	4" (10.16 cm)			
Network Media				
10BaseT	100BaseTX	100BaseFX	100BaseFXE	
≥CAT3 Cable	≥CAT5 Cable	Multimode: 50-62.5/125µm	Singlemode: 7-10/125µm	
Switch Properties				
Number of MAC Addresses		Aging Time	Latency (Typical)	Switching Method
8,000		Programmable	2.6 µs	Store & Forward

Refer to ["100 MB Fiber Transceiver Characteristics"](#)

\* High Voltage - HV option



### 1.7.3 716FX2 Dimensions

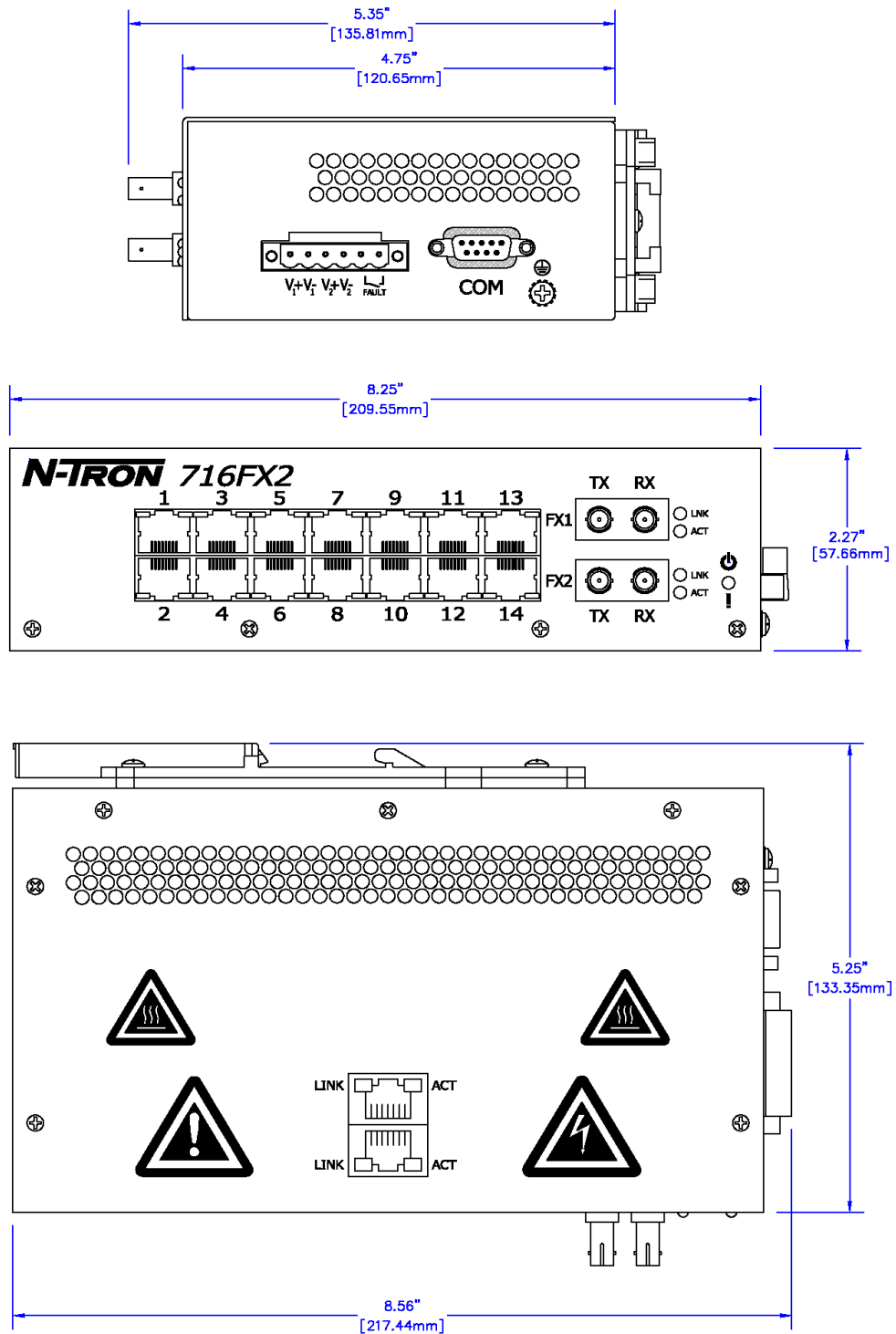

All specifications are subject to change. Consult the company website for more information.



## 1.8 716M12

The versatile 716M12 Industrial Ethernet managed switch features 16 10/100 BaseTX M12 D-Coded copper ports and redundant 10-49 VDC power inputs (HV 40-160 VDC available). Designed to handle the most demanding environments with IP rated protection against exposure to low/high pressure water jets and protection against temporary immersion in water. The fully managed switch is ideally suited for connecting Ethernet enabled devices in railway, industrial and security applications.

### 1.8.1 Features and Benefits

#### Features and Benefits

Full IEEE 802.3 Compliance  
16 10/100 Base-TX M12 D-Coded Copper Ports  
Redundant 10 to 49 VDC Power Inputs

- Keeps network running in the event of a power supply failure.
- –HV High Voltage Option (40-160VDC)

-40 °C to 85 °C operating temperature  
-40 °C to 80 °C operating temperature (HV Option)  
ESD and Surge Protection Diodes on all Built-in Ports  
IP65 Rated for protection against low pressure jets of water from any direction  
IP66 Rated for protection against high pressure jets of water from any direction  
IP67 Rated for protection against temporary immersion in water  
IP67 Rated Hardened Metal Enclosure  
Autosensing 10/100BaseTX, Duplex, and MDIX  
Offers Rapid Spanning Tree Protocol  
Trunk with other N-Tron trunking capable switches over two ports  
Store & Forward Technology  
Plug-and-Play IGMP Support  
Rugged DIN-Rail Mounting (optional)  
SNMP v1, v2 and v3  
Web Browsing and N-View Switch Monitoring  
Configurable Bi-Color Fault Status LED

#### Fully Managed Features Include:

- Full SNMP and Web Browser Management
- Configuration Backup via Optional Configuration Device (700-NTCD-M12)
- Detailed Ring Map and Fault Location Charting
- IGMP
- N-Ring™ Technology with ~30ms Healing
- N-Link™ Redundant Ring Technology
- N-View™ OPC Monitoring
- 802.1Q VLAN Tagging and Port VLAN
- 802.1p QoS and Port QoS
- 802.1d, 802.1w, 802.1D RSTP (Rapid Spanning Tree)
- Ethernet/IP™ CIP Messaging
- LLDP (Link Layer Discovery Protocol)
- Trunking and Port Mirroring
- DHCP Client, Server, Option 82 relay, Option 61, and IP Fallback
- Local Port IP Addressing
- Port Security-MAC Address Based

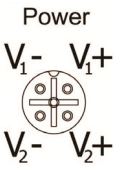
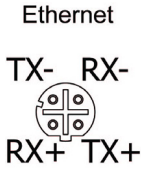

### 1.8.2 716M12 Specifications

Mechanical				
<b>Height</b>	<b>Width</b>	<b>Depth</b>	<b>Weight</b>	<b>Mount</b>
6.7" (16.9 cm)	6.7" (16.9 cm)	2.2" (5.6 cm)	4.6 lbs (2.1 kg)	35mm DIN-Rail (Optional)
Power Input				
<b>Input Voltage</b>	<b>Steady Input Current</b>	<b>Inrush Current</b>	<b>BTU/hr</b>	
10-49 VDC (Regulated)	350 mA @ 24 VDC	18.0 A /0.1 ms @ 24 VDC	28.7 @ 24 VDC	
40-160 VDC (Regulated)*	73 mA @ 124 VDC*		30.9 @ 124 VDC*	
Environmental				
<b>Operating Temperature</b>	<b>Storage Temperature</b>	<b>Operating Humidity</b>		<b>Operating Altitude</b>
-40 °C to 85 °C -40 °C to 80 °C (HV)	-40 °C to 85 °C	5% to 100% (non condensing)		0 to 10,000 ft.
Shock and Vibration				
<b>Shock</b>	<b>Vibration</b>		<b>Note</b>	
200g @ 10 ms	50g, 5-200Hz, Triaxial		Unit must be bulkhead mounted to achieve these levels.	
Connectors				
10/100BaseTX: 16 M12 D Coded Female Copper Ports			POWER: One M12 A Coded Male Port	
COM: One M12 A Coded Female CLI Port			NTCD-M12: One M12 A Coded Female Configuration Device Port	
Pin Assignments				
Power 			Ethernet 	
Recommended Minimum Wiring Clearance				
<b>Front</b>	4" (10.16 cm)			
Network Media				
<b>10BaseT</b>		<b>100BaseTX</b>		
≥CAT3 Cable		≥CAT5 Cable		
Switch Properties				
<b>Number of MAC Addresses</b>		<b>Aging Time</b>	<b>Latency (Typical)</b>	<b>Switching Method</b>
8,000		Programmable	2.9 μs	Store & Forward

\* High Voltage - HV option



### 1.8.3 716M12 Dimensions

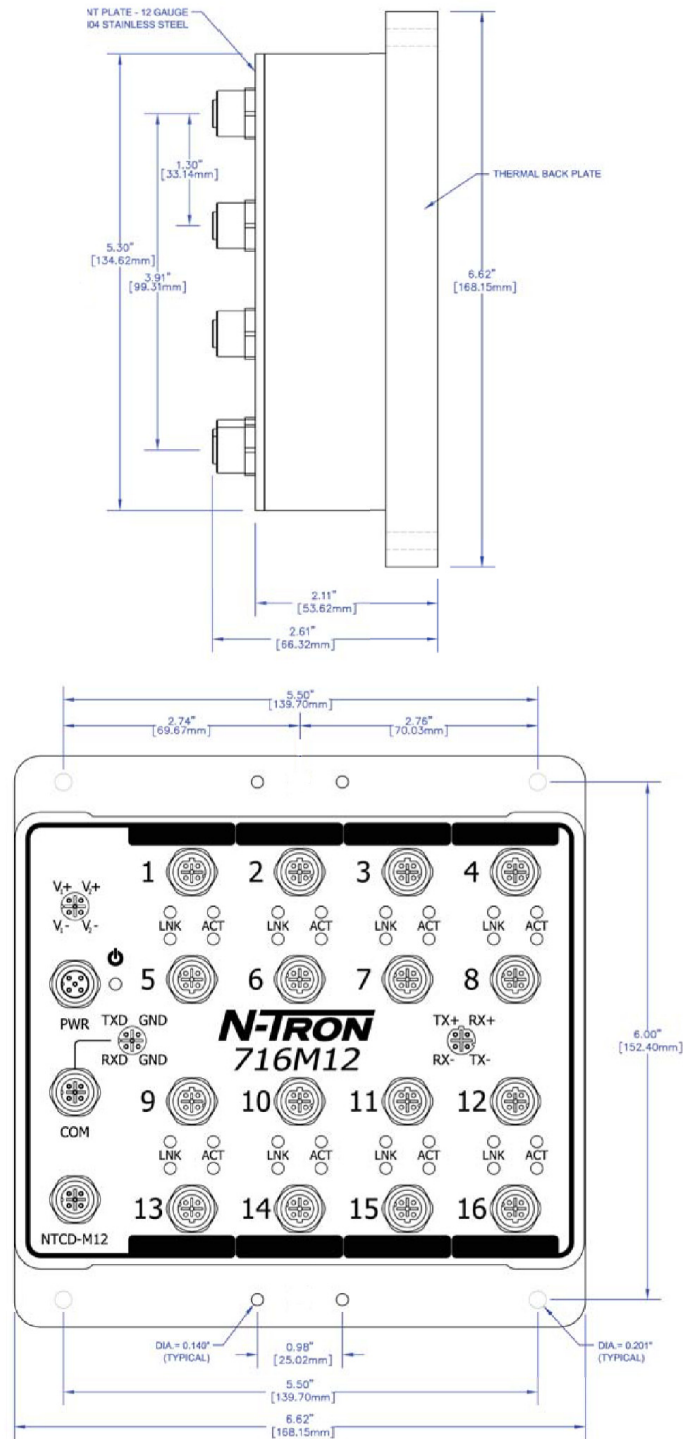

All specifications are subject to change. Consult the company website for more information.



# 1.9 7018TX

The versatile 7018TX Industrial Ethernet managed switch features 16 10/100 BaseTX RJ45 copper ports and two optional SFP (Mini-GBIC) transceiver ports housed in a hardened metal DIN-Rail enclosure with redundant 10-30 VDC power inputs (HV 40-160 VDC available). Designed to handle the most demanding environments, the 7018TX offers outstanding performance, expanded shock and vibration ratings and wide -40 °C to 70 °C operating temperature ratings. The fully managed switch is ideally suited for connecting Ethernet enabled industrial and/or security equipment.

## 1.9.1 Features and Benefits

### Features and Benefits

Full IEEE 802.3 Compliance  
 16 10/100 Base-T(X) RJ45 Copper Ports  
 Two Optional SFP (Mini-GBIC) Transceivers

- 1000BaseSX/LX Ports, LC style
- 1000BaseT Ports, RJ45 style

Redundant 10 to 30 VDC Power Inputs

- Keeps network running in the event of a power supply failure.
- -HV High Voltage Option (40-160VDC)

-40 °C to 70 °C operating temperature  
 ESD and Surge Protection Diodes on all Ports  
 Autosensing 10/100BaseTX, Duplex, and MDIX  
 Offers Rapid Spanning Tree Protocol  
 Trunk with other N-Tron trunking capable switches over two ports  
 Store & Forward Technology  
 Plug-and-Play IGMP Support  
 Rugged DIN-Rail Enclosure  
 SNMP v1, v2 and v3  
 Web Browsing and N-View Switch Monitoring  
 Configurable Alarm Contact  
 Configurable Bi-Color Fault Status LED

### Fully Managed Features Include:

- Full SNMP and Web Browser Management
- Detailed Ring Map and Fault Location Charting
- IGMP Auto Configuration
- N-Ring™ Technology with ~30ms Healing
- N-Link™ Redundant Ring Technology
- N-View™ OPC Monitoring
- 802.1Q VLAN Tagging and Port VLAN
- 802.1p QoS and Port QoS
- 802.1d, 802.1w, 802.1D RSTP (Rapid Spanning Tree)
- Ethernet/IP™ CIP Messaging
- 802.1AB-2005 LLDP (Link Layer Discovery Protocol)
- Trunking and Port Mirroring
- DHCP Client, Server, Option 82 relay, Option 61, and IP Fallback
- Local Port IP Address
- Port Security-MAC Address Based



## 1.9.2 7018TX Specifications

Mechanical				
Height	Width	Depth	Weight	Mount
2.27" (5.8 cm)	8.25" (20.95 cm)	4.75" (12.06 cm)	3.3 lbs (1.49 kg)	35mm DIN-Rail
Power Input				
Input Voltage	Steady Input Current	BTU/hr		
10-30 VDC (Regulated)	620 mA @ 24 VDC	50.8 @ 24 VDC		
40-160 VDC (Regulated)*	160 mA @ 124 VDC*	67.7 @ 124 VDC*		
Environmental				
Operating Temperature	Storage Temperature	Operating Humidity		Operating Altitude
-40 °C to 70 °C	-40 °C to 85 °C	5% to 95% (non condensing)		0 to 10,000 ft.
Shock and Vibration				
Shock	Vibration		Note	
200g @ 10ms	50g, 5-200Hz, Triaxial		Unit must be bulkhead mounted to achieve these levels.	
Connectors				
10/100BaseTX: 16 RJ45 Copper Ports Optional SFP Ports: 1000BaseT: Up to two RJ45 Gigabit Copper Ports or, 1000BaseSX/LX: Up to two LC Duplex Gigabit Fiber Ports				
Recommended Minimum Wiring Clearance				
Side	1" (2.54 cm)			
Front	4" (10.16 cm)			
Network Media				
10BaseT	100BaseTX	1000BaseT	1000BaseSX	1000BaseLX
≥CAT3 Cable	≥CAT5 Cable	≥CAT5e Cable	Multimode: 50-62.5/125µm	Singlemode: 7-10/125µm
Switch Properties				
Number of MAC Addresses		Aging Time	Latency (Typical)	Switching Method
8,000		Programmable	2.6 µs	Store & Forward

Refer to ["Gigabit Fiber Transceiver \(SFP\) Characteristics"](#)

\* High Voltage - HV option





### 1.9.3 7018TX Dimensions

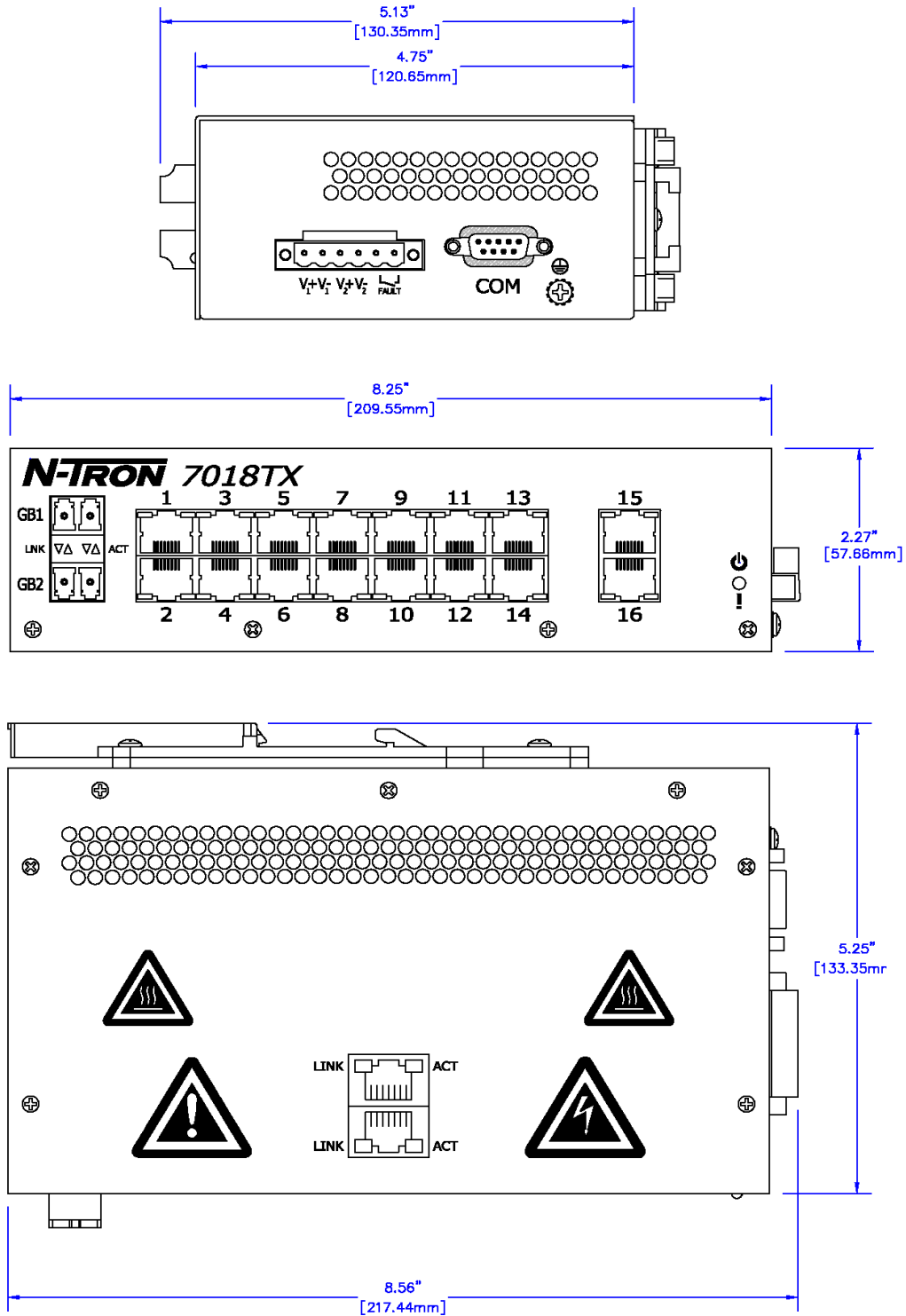

All specifications are subject to change. Consult the company website for more information.



## 1.10 7018FX2

The versatile 7018FX2 Industrial Ethernet managed switch features 14 10/100 BaseTX RJ45 copper ports, up to two optional SFP transceiver ports and two 100Base ST or SC fiber ports housed in a hardened metal DIN-Rail enclosure with redundant 10-30 VDC power inputs (HV 40-160 VDC available). Designed to handle the most demanding environments, the 7018FX2 offers outstanding performance, expanded shock and vibration ratings and wide -40 °C to 70 °C operating temperature ratings. The fully managed switch is ideally suited for connecting Ethernet enabled industrial and/or security equipment.

### 1.10.1 Features and Benefits

#### Features and Benefits

Full IEEE 802.3 Compliance  
14 10/100 Base-T(X) RJ45 Copper Ports  
Two 100BaseFX Fiber Ports, ST or SC  
Two Optional SFP (mini-GBIC) Gigabit Transceivers

- 1000BaseSX/LX Ports, LC style
- 1000BaseT Ports, RJ45 style

Redundant 10 to 30 VDC Power Inputs

- Keeps network running in the event of a power supply failure
- HV High Voltage Option (40-160 VDC)

-40 °C to 70 °C operating temperature  
ESD and Surge Protection Diodes on all Ports  
Autosensing 10/100BaseTX, Duplex, and MDIX  
Offers Rapid Spanning Tree Protocol  
Trunk with other N-Tron trunking capable switches over two ports  
Store & Forward Technology  
Plug-and-Play IGMP Support  
Rugged DIN-Rail Enclosure  
SNMP v1, v2 and v3  
Web Browsing and N-View Switch Monitoring  
Configurable Alarm Contact  
Configurable Bi-Color Fault Status LED

#### Fully Managed Features Include:

- Full SNMP and Web Browser Management
- Detailed Ring Map and Fault Location Charting
- IGMP Auto Configuration
- N-Ring™ Technology with ~30ms Healing
- N-Link™ Redundant Ring Technology
- N-View™ OPC Monitoring
- 802.1Q VLAN Tagging and Port VLAN
- 802.1p QoS and Port QoS
- 802.1d, 802.1w, 802.1D RSTP (Rapid Spanning Tree)
- Ethernet/IP™ CIP Messaging
- 802.1AB-2005 LLDP (Link Layer Discovery Protocol)
- Trunking and Port Mirroring
- DHCP Client, Server, Option 82 relay, Option 61, and IP Fallback
- Local Port IP Addressing
- Port Security-MAC Address Based



### 1.10.2 7018FX2 Specifications

Mechanical				
Height	Width	Depth	Weight	Mount
2.27" (5.8 cm)	8.25" (20.95 cm)	4.75" (12.06 cm)	3.3 lbs (1.49 kg)	35mm DIN-Rail
Power Input				
Input Voltage	Steady Input Current	BTU/hr		
10-30 VDC (Regulated)	620 mA @ 24 VDC	50.8 @ 24 VDC		
40-160 VDC (Regulated)*	160 mA @ 124 VDC*	67.7 @ 124 VDC*		
Environmental				
Operating Temperature	Storage Temperature	Operating Humidity		Operating Altitude
-40 °C to 70 °C	-40 °C to 85 °C	5% to 95% (non condensing)		0 to 10,000 ft.
Shock and Vibration				
Shock	Vibration		Note	
200g @ 10ms	50g, 5-200Hz, Triaxial		Unit must be bulkhead mounted to achieve these levels.	
Connectors				
10/100BaseTX: 14 RJ45 Copper Ports 100BaseFX: Two SC or ST Duplex Fiber Ports Optional SFP Ports: 1000BaseT: Up to two RJ45 Gigabit Copper Ports or, 1000BaseSX/LX: Up to two LC Duplex Gigabit Fiber Ports				
Recommended Minimum Wiring Clearance				
Side	1" (2.54 cm)			
Front	4" (10.16 cm)			
Network Media				
10BaseT	100BaseTX	1000BaseT	100BaseFX, 1000BaseSX	100BaseFXE, 1000BaseLX
≥CAT3 Cable	≥CAT5 Cable	≥CAT5e Cable	Multimode: 50-62.5/125µm	Singlemode: 7-10/125µm
Switch Properties				
Number of MAC Addresses		Aging Time	Latency (Typical)	Switching Method
8,000		Programmable	2.6 µs	Store & Forward

Refer to "100 MB Fiber Transceiver Characteristics"

Refer to "Gigabit Fiber Transceiver (SFP) Characteristics"

\* High Voltage - HV option



### 1.10.3 7018FX2 Dimensions

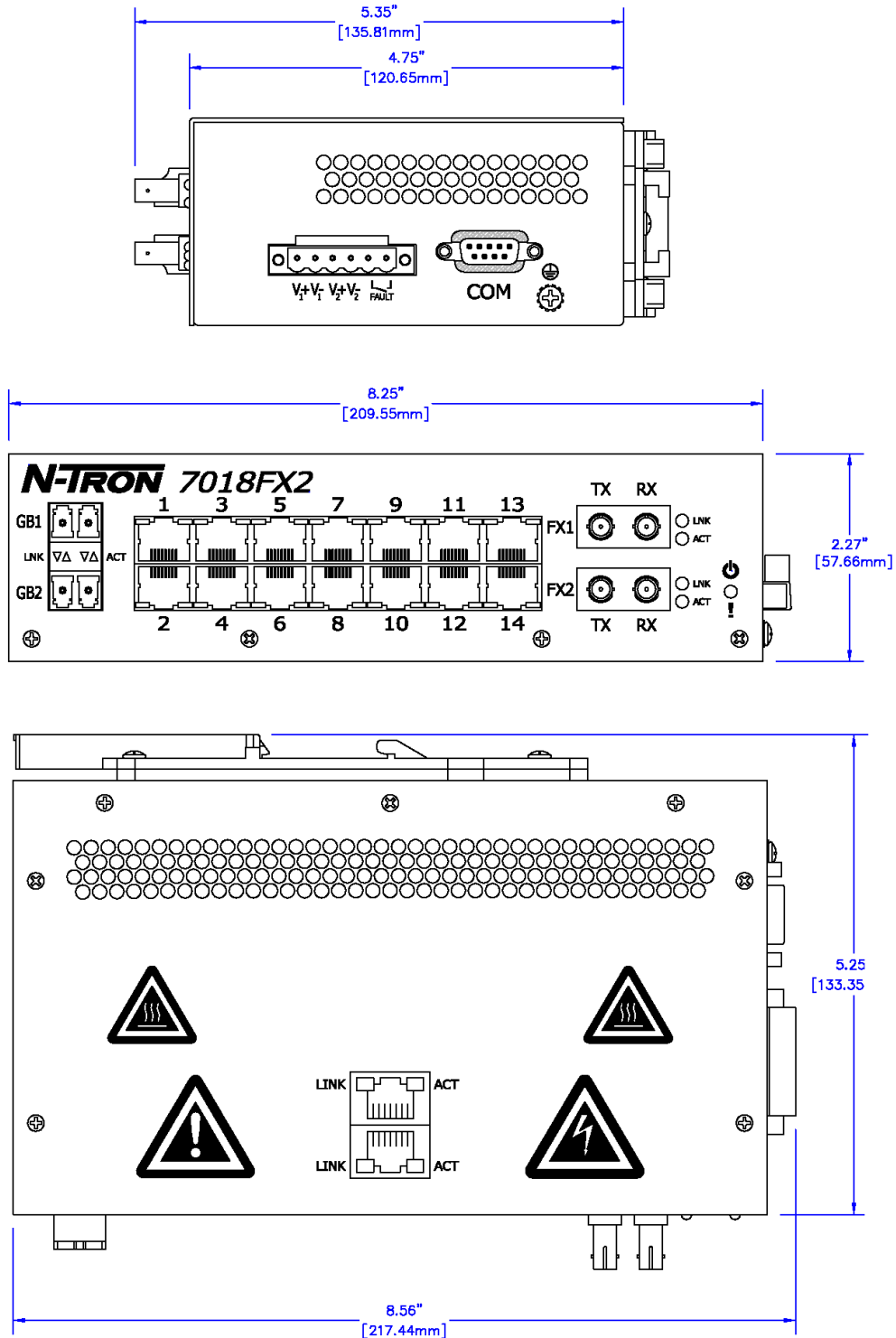

All specifications are subject to change. Consult the company website for more information.



# 1.11 Transceiver Characteristics

## 1.11.1 100 MB Fiber Transceiver Characteristics

<b>Fiber Length</b>	2 km*	15 km**	40 km**	80 km**
<b>TX Power Min</b>	-19 dBm	-15 dBm	-5 dBm	-5 dBm
<b>RX Sensitivity Max</b>	-31 dBm	-31 dBm	-34 dBm	-34 dBm
<b>Wavelength</b>	1310 nm	1310 nm	1310 nm	1550 nm

\* Multimode Fiber Optic Cable

\*\* Singlemode Fiber Optic Cable

## 1.11.2 Gigabit Fiber Transceiver (SFP) Characteristics

<b>Fiber Length</b>	550 m* @ 50/125 $\mu$ m 275 m @ 62.5/125 $\mu$ m	10 km**	40 km**	80 km**
<b>TX Power Min</b>	-9.5 dBm	-9.5 dBm	-2 dBm	0 dBm
<b>RX Sensitivity Max</b>	-17 dBm	-20 dBm	-22 dBm	-24 dBm
<b>Wavelength</b>	850 nm	1310 nm	1310 nm	1550 nm
<b>Assumed Fiber Loss</b>	3.5 to 3.75 dB/km	0.45 dB/km	0.35 dB/km	0.25 dB/km
<b>Laser Type</b>	VCSEL	FP	DFB	DFB

\* SX Fiber Optic Cable

\*\* LX Fiber Optic Cable

**Note:** Fiber Length distances represent typical performance. Link budgets should be evaluated based on specific application conditions.

## 1.12 LEDs

Data ports have two LEDs located on each connector. The left LED indicates link status, and the right LED indicates activity, labeled LNK and ACT. The LNK LED indicates link status and the ACT LED indicates activity.

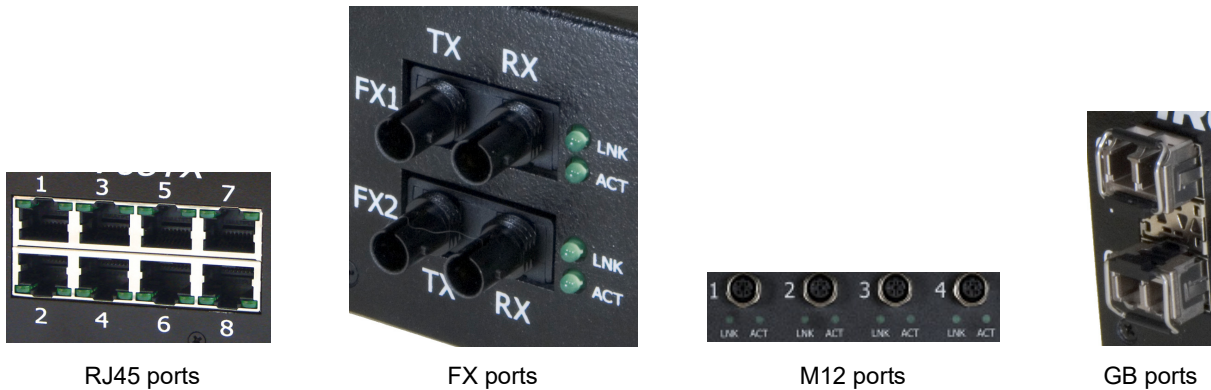

The table below describes the operating modes:

LED	Color	Description
	Green	Power is On with no active faults.
	Red	Power is On and an active fault.
	Off	Power is Off
LNK	Green	10/100/1000 Mb Link between ports
	Off	No link established
ACT	Green (Blinking)	Link is established. Data is active between ports. Activity light blink rate indicates activity, not necessarily the volume of activity
	Off	Data is inactive between ports

# 1.13 Ordering Guide

## 1.13.1 708TX

Part Number	Description
708TX	Eight Port 10/100Base-TX Ports Managed Industrial Ethernet Switch
700-PM	Panel Mount Kit
NTPS-24-1.3	Power Supply 1.3 Amp @ 24 VDC
URMK	19" Universal Rack Mount Kit



## 1.13.2 708FX2 / 708FXE2

Part Number	Description
708FX2-XX	Six Port 10/100Base-TX Ports, Two Multimode 100BaseFX Fiber Optic Ports Managed Industrial Ethernet Switch
708FXE2-XX-YY	Six Port 10/100Base-TX Ports, Two Singlemode 100BaseFX Fiber Optic Ports Managed Industrial Ethernet Switch
700-PM	Panel Mount Kit
9000-UTA107	Optional Metal DIN-Rail Mount
NTPS-24-1.3	Power Supply 1.3 Amp @ 24 VDC
URMK	19" Universal Rack Mount Kit

Where XX = ST or SC connector  
Where YY = 15, 40, or 80 for Singlemode, Blank for Multimode  
Where E = Singlemode, and Blank Otherwise



### 1.13.3 716TX

Part Number	Description
716TX-VV	16 Port 10/100Base-TX Ports, Managed Industrial Ethernet Switch
700-PM	Panel Mount Kit
NTPS-24-1.3	Power Supply 1.3 Amp @ 24 VDC
NTPS-48-2	Power Supply 2 Amp @ 48 VDC (For use with -HV model only)
URMK	19" Universal Rack Mount Kit

Where VV = HV for High Voltage, and Blank for Standard voltage





### 1.13.4 716FX2

Part Number	Description
716FX2-XX-VV	14 Port 10/100Base-TX Ports, Two Multimode 100BaseFX Fiber Optic Ports Managed Industrial Ethernet Switch
716FXE2-XX-YY-VV	14 Port 10/100Base-TX Ports, Two Singlemode 100BaseFX Fiber Optic Ports Managed Industrial Ethernet Switch
700-PM	Panel Mount Kit
NTPS-24-1.3	Power Supply 1.3 Amp @ 24 VDC
NTPS-48-2	Power Supply 2 Amp @ 48 VDC (For use with -HV model only)
URMK	19" Universal Rack Mount Kit

Where XX = ST or SC connector  
 Where YY = 15, 40, or 80 for Singlemode, Blank for Multimode  
 Where E = Singlemode, and Blank Otherwise  
 Where VV = HV for High Voltage, and Blank for Standard voltage



### 1.13.5 7018TX

Part Number	Description
7018TX-VV	16 10/100Base-TX Ports, Two Optional Gigabit SFP Ports Managed Industrial Ethernet Switch
NTSFP-TX	1000BaseT copper SFP (Mini-GBIC) Transceiver (RJ45 connector)
NTSFP-SX	1000BaseSX multimode fiber SFP (Mini-GBIC) Transceiver (LC style connector)
NTSFP-LX-ZZ	1000BaseLX singlemode fiber SFP (Mini-GBIC) Transceiver (LC style connector)
700-PM	Panel Mount Kit
NTPS-24-1.3	Power Supply 1.3 Amp @ 24 VDC
NTPS-48-2	Power Supply 2 Amp @ 48 VDC (For use with -HV model only)
URMK	19" Universal Rack Mount Kit

Where ZZ = 10, 40, or 80 GB Singlemode  
 If SFP Transceiver is not specified at the time of purchase, slots will remain blank with covers.  
 Where VV = HV for High Voltage, and Blank for Standard voltage



### 1.13.6 7018FX2

Part Number	Description
7018FX2-XX-VV	14 10/100Base-TX Ports, Two Multimode 100BaseFX Fiber Optic Ports, Two Optional Gigabit SFP Ports Managed Industrial Ethernet Switch
7018FXE2-XX-YY-VV	14 10/100Base-TX Ports, Two Singlemode 100BaseFX Fiber Optic Ports, Two Optional Gigabit SFP Ports Managed Industrial Ethernet Switch
NTSFP-TX	1000BaseT copper SFP (Mini-GBIC) Transceiver (RJ45 connector)
NTSFP-SX	1000BaseSX multimode fiber SFP (Mini-GBIC) Transceiver (LC style connector)
NTSFP-LX-ZZ	1000BaseLX singlemode fiber SFP (Mini-GBIC) Transceiver (LC style connector)
700-PM	Panel Mount Kit
NTPS-24-1.3	Power Supply 1.3 Amp @ 24 VDC
NTPS-48-2	Power Supply 2 Amp @ 48 VDC (For use with -HV model only)
URMK	19" Universal Rack Mount Kit

Where XX = ST or SC connector  
 Where YY = 15, 40, or 80 for Singlemode, Blank for Multimode  
 Where E = Singlemode, and Blank Otherwise  
 Where ZZ = 10, 40, or 80 GB Singlemode  
 If SFP Transceiver is not specified at the time of purchase, slots will remain blank with covers.  
 Where VV = HV for High Voltage, Blank for standard voltage



### 1.13.7 708M12

Part Number	Description
708M12-VV	IP67-rated, Eight 10/100Base-TX Ports, Managed Industrial Ethernet Switch with M12 D-coded female 4-pin connectors
700-NTCD-M12	Configuration Device for saving and restoring configuration parameters.
NTPS-24-1.3	Power Supply 1.3 Amp @ 24 VDC
NTPS-48-2	Power Supply 2 Amp @ 48 VDC (For use with -HV model only)
M12DRC-ISO	DIN-Rail kit, Plastic
M12DRC-MTL	DIN-Rail kit
CAT5E-M12-M12-X	Straight M12 to Straight M12, Shielded
CAT5E-M12-RJ45-X	Straight M12 to Straight RJ45, Shielded
CAT5E-M12-X	Straight M12 to Bare End, Shielded
CAT5E-RM12-M12-X	90° M12 to Straight M12, Shielded
CAT5E-RM12-RM12-X	90° M12 to 90° M12, Shielded
CAT5E-RM12-RJ45-X	90° M12 to RJ45, Shielded
CAT5E-RM12-X	90° M12 to Bare End, Shielded
PWR-M12-A-X	Power Cable, M12 A-Coded Straight Female to Bare End, Shielded
PWR-RM12-A-X	Power Cable, M12 A-Coded 90° Female to Bare End, Shielded
SERIAL-DB9-M12	Serial Cable, DB9 to M12, 5 ft., Shielded
SERIAL-DB9-RM12	Serial Cable, DB9 to 90°M12, 5 ft., Shielded

Where X = Length of Cable, Fill in Desired Amount in Feet  
 Example: CAT5E-RM12-10 (for a 10 ft cable)  
 Where VV = HV for High Voltage, Blank for standard voltage



### 1.13.8 716M12

Part Number	Description
716M12-VV	IP67-Rated, 16 10/100Base-TX Ports, Managed Industrial Ethernet Switch with M12 D-coded Female 4-pin Connectors
700-NTCD-M12	Configuration Device for saving and restoring configuration parameters.
NTPS-24-1.3	Power Supply 1.3 Amp @ 24 VDC
NTPS-48-2	Power Supply 2 Amp @ 48 VDC
M12DRC-ISO	DIN-Rail kit, Plastic
CAT5E-M12-M12-X	Straight M12 to Straight M12, Shielded
CAT5E-M12-RJ45-X	Straight M12 to Straight RJ45, Shielded
CAT5E-M12-X	Straight M12 to Bare End, Shielded
CAT5E-RM12-M12-X	90° M12 to Straight M12, Shielded
CAT5E-RM12-RM12-X	90° M12 to 90° M12, Shielded
CAT5E-RM12-RJ45-X	90° M12 to RJ45, Shielded
CAT5E-RM12-X	90° M12 to Bare End, Shielded
PWR-M12-A-X	Power Cable, M12 A-Coded Straight Female to Bare End, Shielded
PWR-RM12-A-X	Power Cable, M12 A-Coded 90° Female to Bare End, Shielded
SERIAL-DB9-M12	Serial Cable, DB9 to M12, 5 ft., Shielded
SERIAL-DB9-RM12	Serial Cable, DB9 to 90°M12, 5 ft., Shielded

Where X = Length of Cable, Fill in Desired Amount in Feet  
Example: CAT5E-RM12-10 (for a 10 ft cable)  
Where VV = HV for High Voltage, Blank for standard voltage



This Page Intentionally Left Blank



# Chapter 2 Hardware Installation

## 2.1 Unpacking

Remove all the equipment from the packaging and store the packaging in a safe place. File any damage claims with the carrier.

Make certain the N-Tron® Series 700/7000 Ethernet Switch package contains the following items:

1. 700/7000 switch
2. Product CD

## 2.2 ATEX Installation Requirements (708 Series Only)

1. The conductor size of the phase conductor must be in the range of 16-28AWG (0.08mm<sup>2</sup>-1.31mm<sup>2</sup>).
2. Field wiring must be suitable for a minimum of 110°C.
3. Ethernet Switches are intended for mounting in an ATEX-Certified IP54 enclosure in a pollution degree 2 environments as defined by IEC 60664-1.



**II 3 G Ex nA nC IIC T4 Gc DEMKO 03 ATEX 0316686U**

4. Temperature testing of the Ethernet Switches was conducted on the switch itself in an 85°C air-circulating oven and resulted in a Temperature Code of T4. However, end-product temperature testing shall be considered.
5. The end user shall provide bonding means as necessary. All bonding equipment (components) shall be evaluated according to EN 60079-15:2010 and covered by a component certificate for the actual use. When installing bonding components that will pass through an enclosure wall, they must have a minimum of IP54 rating equal to the enclosure. All electrical clearances must be maintained per the manufacturer's instructions of the bonding component or per EN 60079-15:2010.
6. Ethernet Switch requires protection against transients. The end-product shall provide a suitable form of protection that removes the risk of or limits transients to no more than 42V.
7. Products are evaluated to EN 60079-0:2012 and EN 60079-15:2010.

## 2.3 Mounting the Unit

Red Lion offers its 700/7000 switch model Panel Mount Kit (P/N: 700-PM) which may be used to securely mount the 700/7000 models to a panel or other flat surface. Refer to section 1.16 to determine if your switch model works with the Panel Mount Kit.

The proper clearance should be observed on the sides, back, top and bottom to allow proper ventilation. Also, observe the proper cable bend radius for the front and top side of the unit.



### 2.3.1 DIN-Rail Mounting Instructions for 708TX and 708FX2 Models

Install the unit on a standard 35mm Din-Rail. Recess the 708TX unit to allow at least 3" of horizontal clearance for copper cable bend radius. Recess the 708FX2 unit to allow at least 5" of horizontal clearance for fiber cable bend radius.

#### 2.3.1.1 Vertical Mounting 708TX and 708FX2

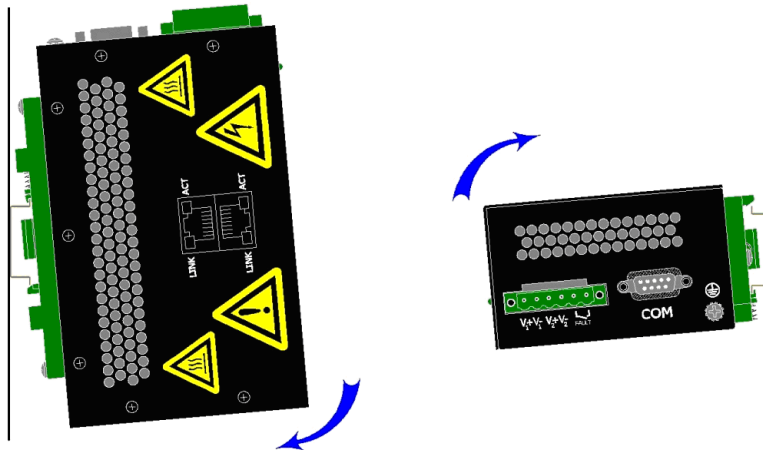

Install the switch to standard 35mm DIN-Rail as shown on the left in the diagram.

**Note:** When mounting the switch in the vertical position, you must orientate the power connector to the top as shown above for proper unit ventilation.

1. First, hook the top of the DIN-Rail clip on the back of the switch to the rail at an upward angle.
2. Then, gently rotate the front of the switch downward, towards the panel.
3. Push the bottom of the switch towards the rail until it locks into place.
4. Apply upward force to verify the switch is securely installed.
5. Connect any communications cables to the switch.
6. Install the power and ground wires.
7. Apply power to the power supply.

#### 2.3.1.2 Horizontal Mounting 708TX and 708FX2

Install the switch to standard 35mm DIN-Rail as shown on the right in the diagram.

1. First, place the bottom edge of the bracket on the back of the unit against the DIN-Rail bottom edge at a downward angle.
2. Then, gently rotate the front of the switch upward, towards the DIN-Rail.
3. Push the top of the switch towards the DIN-Rail until it locks into place.
4. Apply downward force to verify the switch is securely installed.
5. Connect any communications cables to the switch.
6. Install the power and ground wires.
7. Apply power to the power supply.





### 2.3.2 DIN-Rail Mounting Instructions for 716TX, 716FX2, 7018TX and 7018FX2 Models

Install the unit on a standard 35mm Din-Rail. Recess the 716TX unit to allow at least 3" of horizontal clearance for copper cable bend radius. Recess the 716FX2 or 7018FX2 unit to allow at least 5" of horizontal clearance for fiber cable bend radius. There should be at least 4" of clearance on both the top and bottom of the unit to allow proper ventilation.

#### 2.3.2.1 Vertical Mounting 716TX, 716FX2, 7018TX and 7018FX2

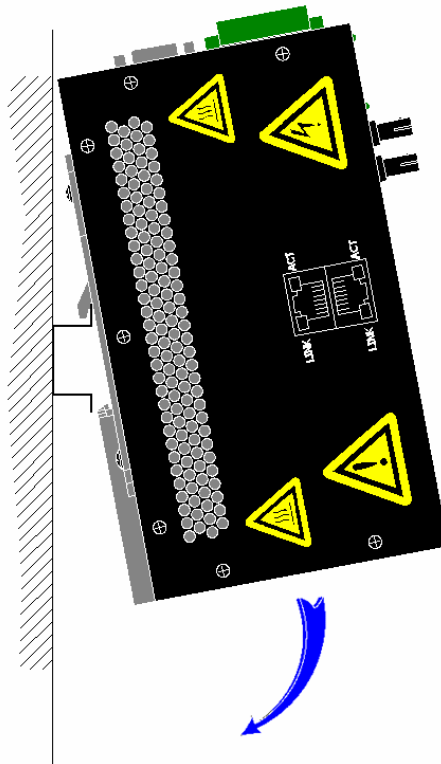

Install the switch to standard 35mm DIN-Rail as shown in the diagram above.

**Note:** When mounting the switch in the vertical position, you must orientate the power connector to the top as shown above for proper unit ventilation.

1. First, hook the top of the DIN-Rail clip on the back of the switch to the rail at an upward angle.
2. Then, gently rotate the front of the switch downward, towards the panel.
3. Push the bottom of the switch towards the rail until it locks into place.
4. Apply upward force to verify the switch is securely installed.
5. Connect any communications cables to the switch.
6. Install the power and ground wires.
7. Apply power to the power supply.

### 2.3.3 DIN-Rail Removal Instructions From Vertical Mounting

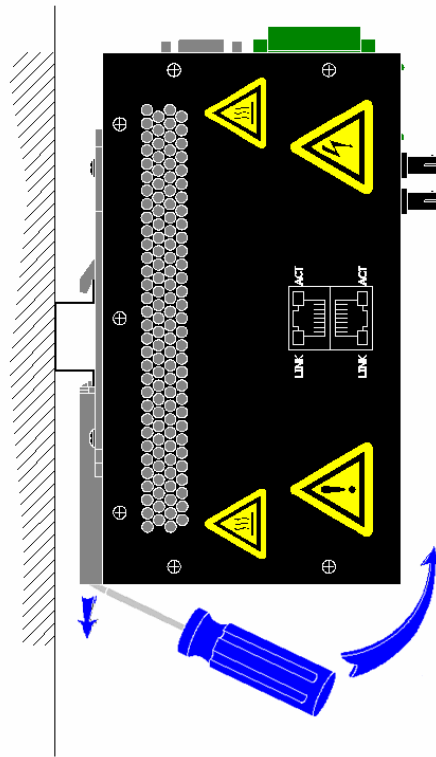

Remove the switch from standard 35mm DIN-Rail as shown in the diagram above.

1. Ensure power from the power source is off.
2. Disconnect power and ground wires.
3. Disconnect any communications cables from the unit.
4. Insert a standard flat/slotted screwdriver into the slot provided on the DIN-Rail clip.
5. Using the base of the switch as a pivot point, apply upward force on the screwdriver to release the DIN-Rail clip.
6. With the DIN-Rail clip latching mechanism released, continue to rotate the switch upward and away from the panel.
7. Once the switch has been rotated upward, remove the screwdriver.

Carefully lift the switch upward and away from the DIN-Rail and panel.

### 2.3.4 Bulkhead Mounting 708M12 and 716M12 Models

The 708M12 and 716M12 models are designed for bulkhead mounting or within an enclosure and are IP67 rated. There are optional Din-Rail mounting kits with metal or plastic clips available. This section includes the mechanical dimensions and drill hole placements to consider when bulkhead mounting the unit. Allow at least 3" of horizontal clearance in the installation location for copper cable bend radius.



### 708M12 and 716M12 Dimensions and Drill Hole Locations

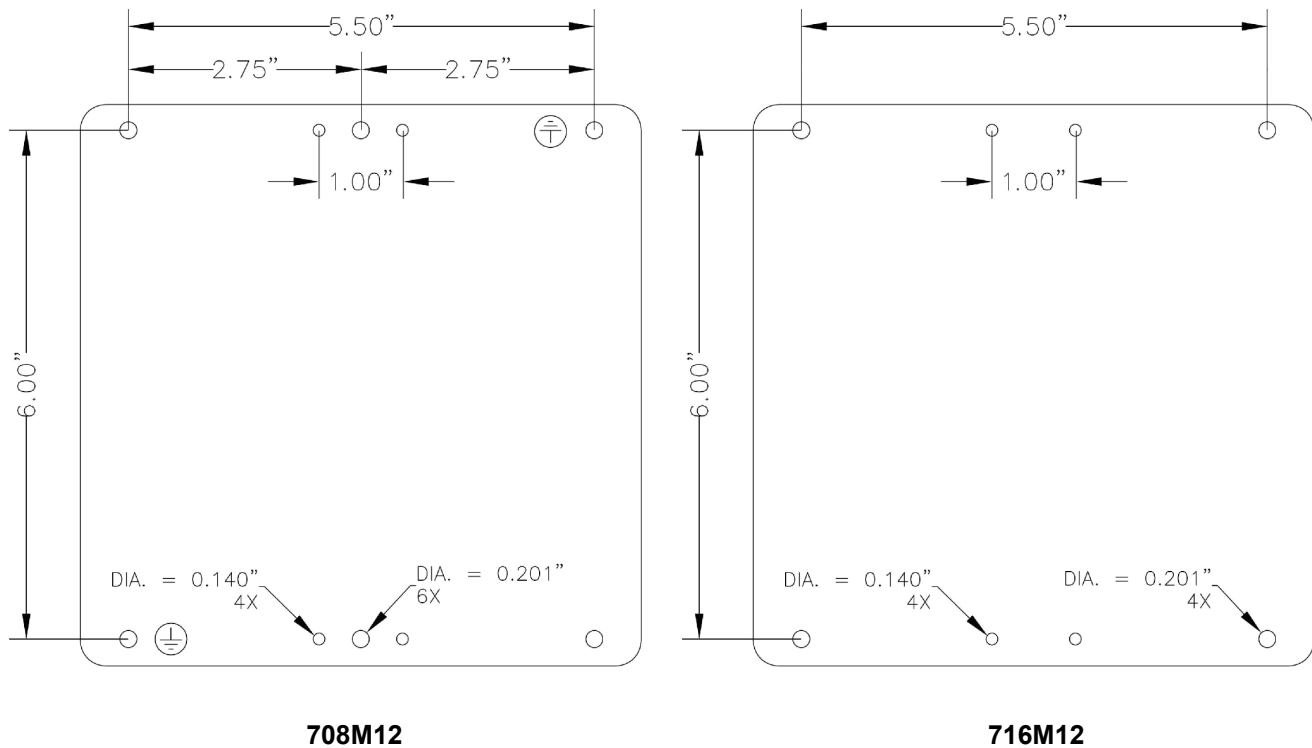

#### 2.3.5 Horizontal DIN-Rail Mounting 708M12 and 716M12

Install the switch to standard 35mm DIN-Rail.

1. Attach the optional M12DRC or M12DRC-ISO DIN-Rail kit to the back of the switch.
2. Place the bottom edge of the bracket on the back of the unit against the DIN-Rail bottom edge at a downward angle.
3. Then, gently rotate the front of the switch upward, towards the DIN-Rail.
4. Push the top of the switch towards the DIN-Rail until it locks into place.
5. Apply downward force to verify the switch is securely installed.
6. Connect any communications cables to the switch.
7. Install the power connector and ground wires.
8. Apply power to the power supply.

## 2.4 Connect Power Source

### 2.4.1 708TX, 708FX2, 716TX, 716FX2, 7018TX and 7018FX2 Models

The 7xx models have a redundant 10-30 VDC power input (HV (High Voltage) 40-160 VDC options are available for some models).

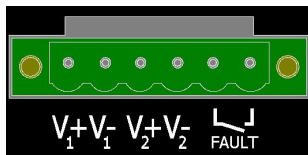
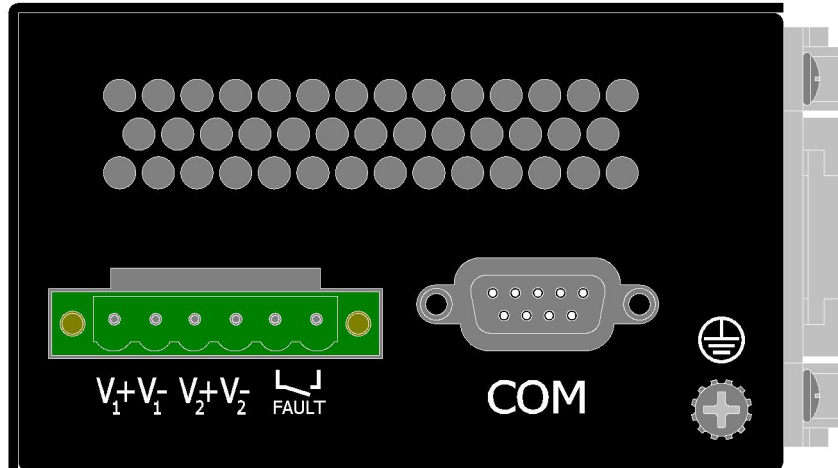

1. Unscrew and remove the DC voltage input plug from the power input header.
2. Install the DC power cables into the plug (observing polarity).
3. Plug the voltage input plug back into the power input header. This is the power disconnect device that must be removed before performing any kind of service or maintenance on the device.
4. Tightening torque for the terminal block power plug is 0.5 Nm/0.368 lb/ft.
5. Verify that the power LED is on (Green).

**Note:** When a DC power supply is installed, only one power supply must be connected to power for minimal operation. For redundant power operation, V1 and V2 inputs must be connected to separate DC voltage sources. This unit will draw current from both sources simultaneously. Use 16-28 AWG (0.08mm<sup>2</sup> - 1.31mm<sup>2</sup>) wire when connecting to the power supply.

**Note:** The Fault pins on the power connector can be used for an alarm contact. The current carrying capacity is 1A at 24VDC. It is normally open and the relay closes when a fault condition occurs. These pins can be used to connect an external warning device such as a light in order to provide an external alarm. The conditions for generating a fault condition (closing the relay) can be configured through software.

Recommended 24 VDC power supply, similar to Red Lion's P/N NTPS-24-1.3.

For HV models, recommended 48 VDC power supply, similar to Red Lion's P/N NTPS-48-2.

Verify that the proper input voltage is connected to the switch before powering on the unit.

**Note:** LEDs are described in detail in [“LEDs” on page 28](#).



## 2.4.2 708M12 and 716M12 Models

The 708M12 model has a redundant 10-30 VDC power input and the 716M12 model has a redundant 10-49 VDC power input. HV (High Voltage) 40-160 VDC models are also available for both the 708M12 and 716M12.

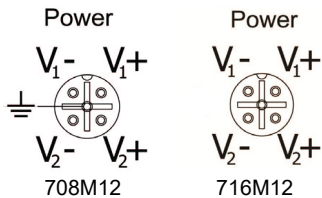

1. Connect the power cable from the power supply to the Unit M12 A-coded power connector.
2. Male end pins of the power cable and corresponding female power connector of the unit must be properly aligned before the connection can be completed.
3. Connect the power cable into the power supply.
4. All unit LED's will flash on momentarily when the power is first connected.
5. Verify that the power LED stays on (Green).

**Note:** Either  $V_1$  or  $V_2$  can be connected to power for minimal operation. For redundant applications both inputs must be provided from the same Class 2 source. The power cord should be limited to less than 10 meters in order to ensure optimum performance.

Recommended 24 VDC power supply, similar to Red Lion's P/N NTPS-24-1.3.

For HV models, recommended 48 VDC power supply, similar to Red Lion's P/N NTPS-48-2.

Verify that the proper input voltage is connected to the switch before powering on the unit.

**Note:** LEDs are described in detail in ["LEDs" on page 28](#).

## 2.5 Grounding the Switch

The grounding of any control system is an integral part of the design. Red Lion switches are designed to be grounded, but the user has been given the flexibility to float the switch when required. The best noise immunity and emissions (i.e. CE) are obtained when the Red Lion switch chassis is connected to earth ground via a drain wire (20 gauge minimum size wire). Some Red Lion switches have metal din-rail brackets that can ground the switch if the din-rail is grounded. In some cases, Red Lion switches with metal brackets can be supplied with optional plastic brackets if isolation is required.

### 2.5.1 Grounding 708TX, 708FX2, 716TX, 716FX2, 7018TX and 7018FX2 Models

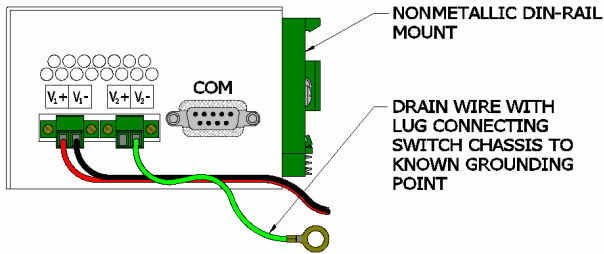

Both V- legs of the power input connector are connected to chassis internally on the PCB. Connecting a drain wire to earth ground from one of the V- terminal plugs as shown here will ground the switch and the chassis. The power leads from the power source should be limited to 3 meters or less in length.

As an alternate, users can run a drain wire & lug from any of the Din-Rail screws or empty PEM nuts on the enclosure. When using an unused PEM nut to connect a ground lug via a machine screw, care should be taken to limit the penetration of the outer skin by less than 1/4 in (NOTE: Recommend #6 32X1/4" Phillips pan head zinc screw). Failure to do so may cause irreversible damage to the internal components of the switch.

**Note:** Before applying power to the grounded switch, you should use a volt meter to verify there is no voltage difference between the power supply's negative output terminal and the switch chassis grounding point.

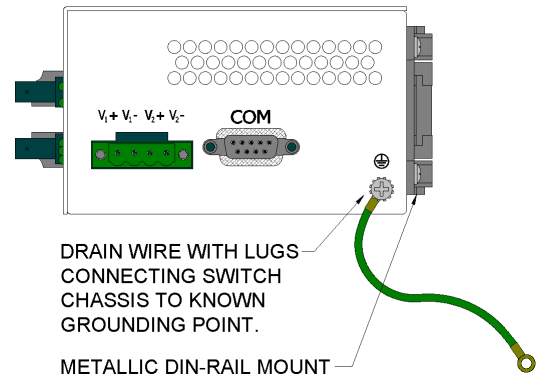

**Remarque:** Avant de mettre sous tension le commutateur de mise à la terre, vous utilisez un voltmètre pour vérifier qu'il n'y a pas de différence de tension entre l'alimentation de la borne de sortie négative et le commutateur de point de mise à la masse du châssis.

If the use of shielded cables is required, it is generally recommended to only connect the shield at one end to prevent ground loops and interfere with low level signals (i.e. thermocouples, RTD, etc.). CAT5e cables manufactured to EIA-568A or 568B specifications are required for use with Red Lion Switches.

In the event all CAT5e patch cable distances are small (i.e. All Ethernet devices are located in the same local cabinet and/or referenced to the same earth ground), it is permissible to use fully shielded cables terminated to chassis ground at both ends in systems void of low level analog signals.

### 2.5.2 Grounding 708M12 and 716M12 Models

Connect a drain wire with lug from the 708M12 or 716M12 switch chassis to a known ground from the switch ground screw as shown here. The power leads from the power source should be limited to 3 meters or less in length. Recommend using a Phillips pan head zinc screw.

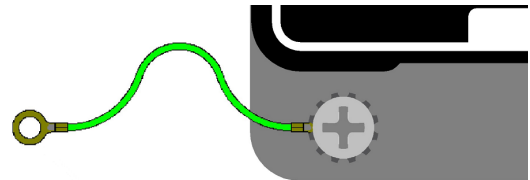

**Note:** Before applying power to the grounded switch, you should use a volt meter to verify there is no voltage difference between the power supply's negative output terminal and the switch chassis grounding point.



**Remarque:** Avant de mettre sous tension le commutateur de mise à la terre, vous utilisez un voltmètre pour vérifier qu'il n'y a pas de différence de tension entre l'alimentation de la borne de sortie négative et le commutateur de point de mise à la masse du châssis.

If the use of shielded cables is required, it is generally recommended to only connect the shield at one end to prevent ground loops and interfere with low level signals (i.e. thermocouples, RTD, etc.). CAT5e cables manufactured to EIA-568A or 568B specifications are required for use with Red Lion Switches.

In the event all CAT5e patch cable distances are small (i.e. All Ethernet devices are located in the same local cabinet and/or referenced to the same earth ground), it is permissible to use fully shielded cables terminated to chassis ground at both ends in systems void of low level analog signals.

## 2.6 Connecting the Switch

### 2.6.1 Connecting the 708TX, 708FX2, 716TX, 716FX2, 7018TX and 7018FX2 Models

For FX/FXE units, remove the dust cap from the fiber optic connectors and connect the fiber optic cables. The TX port on the FX/FXE models should be connected to the RX port of the far end station. The RX port on the FX/FXE versions should be connected to the TX port of the far end station.

For 10/100 Base-TX ports, plug a Category 5E twisted pair cable into the RJ45 connector. Connect the other end to the far end station. Verify that the LNK LEDs are ON once the connection has been completed. To connect any port to another device (end node, Switch or Repeater), use a standard Category 5E straight through or crossover cable with a minimum length of one meter and a maximum length of 100 meters.

Red Lion recommends the use of pre-manufactured CAT5E cables to ensure the best performance. If this is not an option and users must terminate their own ends on the CAT5E cables; one of the two color coded standards shown to the right should be utilized.

If a user does not follow one of these two color code standards then the performance and maximum cable distance will be reduced significantly, and may prevent the switch from establishing a link.

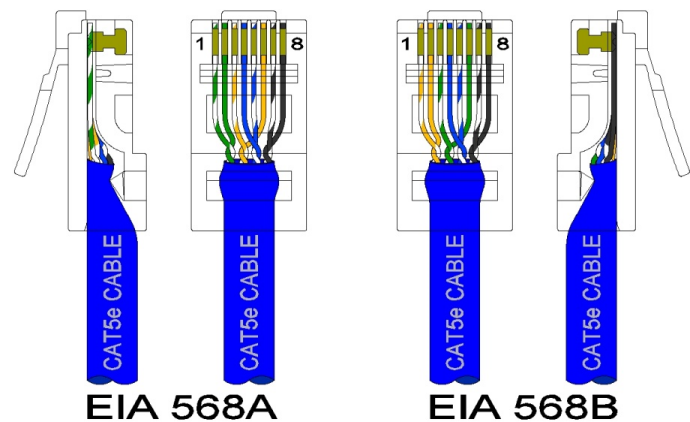

#### Warning / Avertissement

- Creating a network loop without employing a network path protocol such as N-Ring™, N-Link™, or RSTP is an illegal operation that can create a network storm which will crash the network.
- La création d'un réseau sans boucle employant un chemin réseau protocole tels que N-Ring, N-Link, ou RSTP est une opération illégale que peut créer une tempête du réseau qui va planter le réseau.

#### 2.6.1.1 Connect the Ethernet Cable

If you are connecting to the unit via the copper port, you will need a straight or crossover cable with two 8-pin RJ45 connectors on each end.

To visually confirm that Ethernet cabling was done properly, check the LED indication on the Ethernet port of the unit. The link LED should be on when the correct cable is used.

**Note:** A shielded cable is required to fully meet EMC standards.

When using shielded cables, it is generally recommended to only connect the shield at one end to prevent ground loops and interference with low level signals (i.e. thermocouples, RTD, etc.). CAT5e cables manufactured to EIA-568A or 568B specifications are required for use with Red Lion series switches.

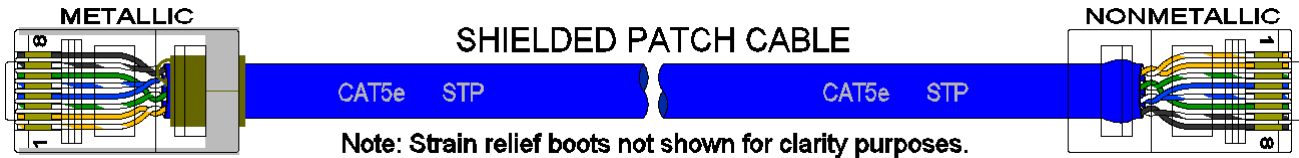

In the event all CAT5e patch cables are short (i.e. All Ethernet devices are located in the same local cabinet and/or referenced to the same earth ground), it is permissible to use fully shielded cables terminated to chassis ground at both ends in systems avoid low level analog signals.

### 2.6.1.2 RJ45 Connector Crimp Specifications

Refer to the illustration below for your CAT5 cable specifications.

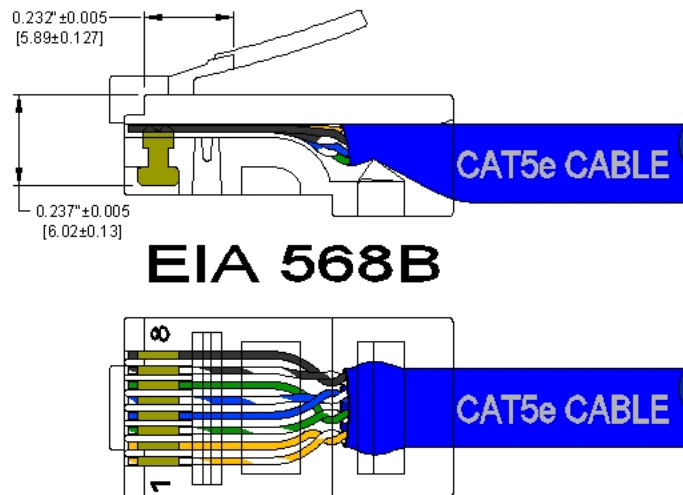



## 2.6.2 708TX, 708FX2, 716TX, 716FX2, 7018TX and 7018FX2 Model Serial Interface

The 700/7000 switch models provide an EIA-232 interface accessed via a DB9-pin female connector (labeled 'COM' on the unit). This is used to access the Command Line Interface (CLI). The pin-outs are shown below.

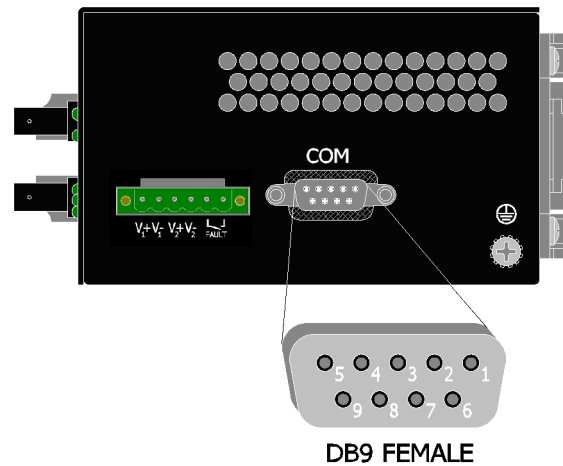

### 2.6.2.1 Serial Cable Connection

Connect the serial COM port of your PC and the 700/7000 model switch using a standard straight through serial cable. You will require a cable with a 9-pin or 25-pin sub-D female connector for the PC end, and a 9-pin male sub-D connector for the 700/7000 switch model end.

The following table shows the pin-out and the connections for both types of cable:

PC Port	25-Pin Female	9-Pin Female	7xx Model 9-Pin Male	
Signal Name	Pin #	Pin #	Pin #	Signal Name
TXD	2	3	3	RXD
RXD	3	2	2	TXD
GND	7	5	5	GND

## 2.6.3 Connecting the 708M12 and 716M12 Models

The 708M12 and 716M12 Industrial Ethernet Switches are fully protected against dust and will remain sealed when immersed in water to a depth of 1 meter for 1 hour when all the ports are properly mated or sealed

For 708M12 and 716M12 units, remove the IP67 cap from the M12 port connectors and connect the Ethernet cables. These IP67 caps seal off the unused ports protecting them from dirt, water, oil or any other contaminants which might be present in close proximity of the switch.

For 10Base-T ports, plug a Category 3 (or greater) twisted pair cable into the M12 connector. Connect the other end to the far end station. For 100Base-T ports, plug a Category 5 (or greater) twisted pair cable into the M12 connector. Verify that the LNK LEDs are ON once the connection has been completed. To connect any port to another device (end node, Switch or Repeater), use a standard Category 5 straight through or crossover cable with a minimum length of one meter and a maximum length of 100 meters.

Red Lion recommends the use of pre-manufactured CAT5 cables with an M12 connector on the switch end to ensure the best performance. If this is not an option and users must terminate their own ends on the CAT5E cables; one of the two color coded standards shown to the right should be utilized. If a user does not follow one of these two color code standards then the performance and maximum cable distance will be reduced significantly, and may prevent the switch from establishing a link.

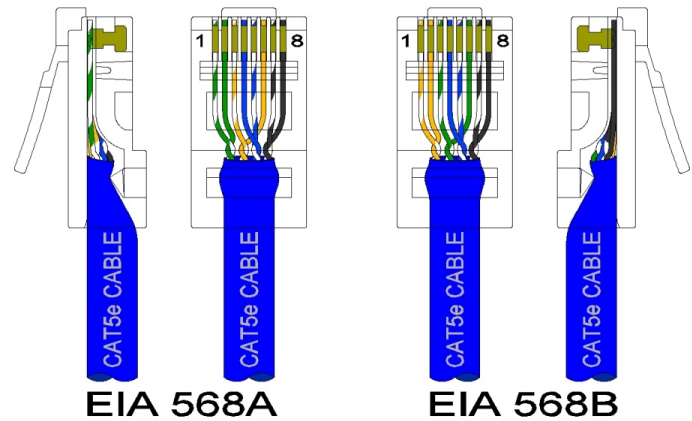

**Warning / Avertissement**

- Creating a network loop without employing a network path protocol such as N-Ring, N-Link, or RSTP is an illegal operation that can create a network storm which will crash the network.
- La création d'un réseau sans boucle employant un chemin réseau protocole tels que N-Ring, N-Link, ou RSTP est une opération illégale que peut créer une tempête du réseau qui va planter le réseau.

**2.6.3.1 708M12 and 716M12 Model Serial Interface**

The 708M12 and 716M12 switch models provide an EIA-232 interface accessed via an A Coded female connector (labeled 'COM' on the unit). This is used to access the Command Line Interface (CLI). The pin-outs are shown below.

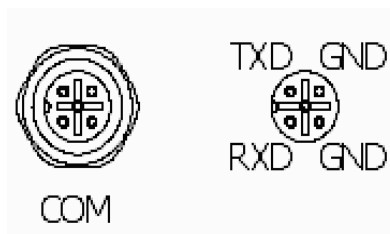

**2.6.3.2 Serial Cable Connection**

Connect the serial COM port of your PC and the 708M12 or 716M12 model switch using the available Serial-DB9-M12 serial cable. You will require a cable with a 9-pin or 25-pin sub-D female connector for the PC end, and a 4-pin A Coded M12 Male connector for the 708M12 or 716M12 end.



The following table shows the pin-out and the connections for both types of cable:

PC Port	25-Pin Female	9-Pin Female	708M12 or 716M12 4-Pin A Coded M12 Male	
Signal Name	Pin #	Pin #	Pin #	Signal Name
TXD	2	3	2	RXD
RXD	3	2	1	TXD
GND	7	5	3/4	GND

### 2.6.4 Configure the Terminal Interface

The following configuration should be used in HyperTerminal.

Setting	Value
Port Settings:	115200
Data Bits:	8
Parity:	None
Stop Bits:	1
Flow Control:	None

## 2.7 700-NTCD-M12 Configuration Device

700-NTCD-M12

Configuration Device



Ideal for saving or restoring switch configuration parameters quickly without the need for a computer or software. Straight M12 A-Coded 4-pin male connector. Includes connection status LED. One configuration device per switch is recommended.

## 2.8 Cleaning

Clean only with a damp cloth. Excess moisture or harsh chemicals can cause damage to the unit.

## 2.9 Troubleshooting

Troubleshooting the device is comprised of a few basic steps as provided below. If these do not resolve the issue then contact Red Lion as per the guidance provided in [“Service Information” on page 53](#).

1. Make sure the  (Power LED) is ON.

2. Make sure you are supplying sufficient current for the version chosen.

**Note:** The Inrush current will exceed the steady state current by ~ 2X.

3. Verify that Link LEDs are ON for connected ports.
4. Verify cabling used between stations.
5. Verify that cabling is Category 5E or greater for 100Mbit operation.

## Chapter 3 Accessing the Web Software Interface

1. Launch a web browser and enter the IP address of the device into the address bar.  
The DHCP Client is enabled by default with the 192.168.1.201 as the fallback address.

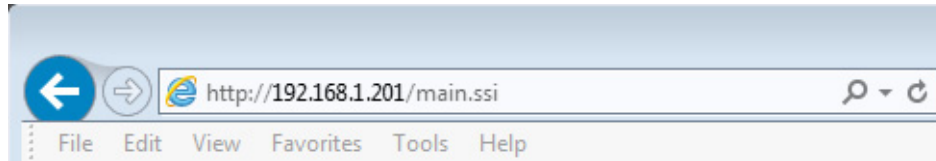

2. The following login screen will appear:

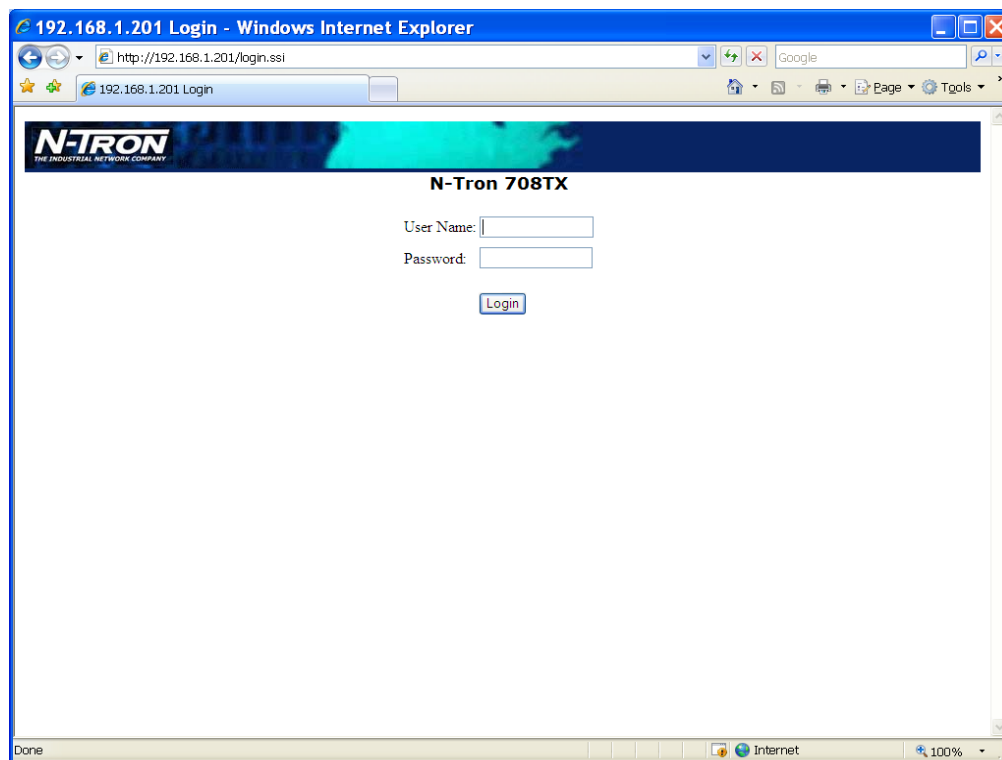

3. For the User Name, enter: **admin** (all lowercase)
4. For the password, enter: **admin** (all lowercase).

**Note:** For security purposes, it is recommended that the password be changed according to your internal policies. Login credentials can be changed on the **User Management** page.

5. Upon successfully logging in, depending on the unit used, a screen similar to the one below will appear:

**N-TRON**  
THE INDUSTRIAL NETWORK COMPANY

- Administration
- DHCP
- LLDP
- Ports
- Statistics
- VLAN
- Bridging
- RSTP
- IGMP
- N-View
- N-Ring
- N-Link
- CIP
- Firmware/Config
- Support
- Rate Limiting
- User Management
- Logical View
- Home
- Config
- Help
- Logout

© 2016 Red Lion Controls, Inc.  
All rights reserved.  
<http://www.redlion.net>  
Logged in as: **admin**

### Product Information

Name	N-TRON 708TX
Software Version	3.9.1
Build Date	Mar 14 2016 at 12:22:02
Boot Loader	BL 2.0.6.1
Copyright	© 2016 Red Lion Controls, Inc.
URL	<a href="http://www.redlion.net">http://www.redlion.net</a>

Please consult the 700/7000 Software Manual (LP0985) for configuration options.

# Service and Support Information

## Service Information

We sincerely hope that you never experience a problem with any of our products. If you do need service, call Red Lion at 1-877-432-9908 for Technical Support. A trained specialist will help you determine the source of the problem. Many problems are easily resolved with a single phone call. If it is necessary to return a unit to us, an RO (Repair Order) can be obtained on the [Red Lion website](#).

Red Lion tracks the flow of returned material with our RO system to ensure speedy service. You must include this RO number on the outside of the box so that your return can be processed immediately.

Be sure to have your original purchase order number and date purchased available.

We suggest that you give us a repair purchase order number in case the repair is not covered under our warranty. You will not be billed if the repair is covered under warranty.

Please supply us with as many details about the problem as you can. The information you supply will be written on the RO form and supplied to the repair department before your unit arrives. This helps us to provide you with the best service, in the fastest manner. Repairs are completed as soon as possible. If you need a quicker turnaround, ship the unit to us by air freight. We give priority service to equipment that arrives by overnight delivery.

We apologize for any inconvenience that the need for repair may cause you. We hope that our rapid service meets your needs. If you have any suggestions to help us improve our service, please give us a call. We appreciate your ideas and will respond to them.

### For Your Convenience:

Please fill in the following and keep this manual with your **RED LION** system for future reference:

P.O. #: \_\_\_\_\_ Date Purchased: \_\_\_\_\_

Purchased From: \_\_\_\_\_ Serial Number: \_\_\_\_\_

MAC Address: \_\_\_\_\_

## Product Support

Inside US: +1 (877) 432-9908

Outside US: +1 (717) 767-6511

Fax: +1 (717) 764-0839

Support: [support.redlion.net](http://support.redlion.net)

Hours: 8:00 am to 6:00 pm EST

Red Lion Controls

20 Willow Springs Circle

York, PA 17406

Website: [www.redlion.net](http://www.redlion.net)



# Limited Warranty

(a) Red Lion Controls Inc., (the “Company”) warrants that all Products shall be free from defects in material and workmanship under normal use for the period of time provided in “Statement of Warranty Periods” (available at [www.redlion.net](http://www.redlion.net)) current at the time of shipment of the Products (the “Warranty Period”). **EXCEPT FOR THE ABOVE-STATED WARRANTY, COMPANY MAKES NO WARRANTY WHATSOEVER WITH RESPECT TO THE PRODUCTS, INCLUDING ANY (A) WARRANTY OF MERCHANTABILITY; (B) WARRANTY OF FITNESS FOR A PARTICULAR PURPOSE; OR (C) WARRANTY AGAINST INFRINGEMENT OF INTELLECTUAL PROPERTY RIGHTS OF A THIRD PARTY; WHETHER EXPRESS OR IMPLIED BY LAW, COURSE OF DEALING, COURSE OF PERFORMANCE, USAGE OF TRADE OR OTHERWISE.** Customer shall be responsible for determining that a Product is suitable for Customer’s use and that such use complies with any applicable local, state or federal law.

(b) The Company shall not be liable for a breach of the warranty set forth in paragraph (a) if (i) the defect is a result of Customer’s failure to store, install, commission or maintain the Product according to specifications; (ii) Customer alters or repairs such Product without the prior written consent of Company.

(c) Subject to paragraph (b), with respect to any such Product during the Warranty Period, Company shall, in its sole discretion, either (i) repair or replace the Product; or (ii) credit or refund the price of Product provided that, if Company so requests, Customer shall, at Company’s expense, return such Product to Company.

**(d) THE REMEDIES SET FORTH IN PARAGRAPH (c) SHALL BE THE CUSTOMER’S SOLE AND EXCLUSIVE REMEDY AND COMPANY’S ENTIRE LIABILITY FOR ANY BREACH OF THE LIMITED WARRANTY SET FORTH IN PARAGRAPH (a).**









N-Tron<sup>®</sup> Series

700/7000 Models - Volume II

Managed Industrial Ethernet Switches

Hardware Manual | August 2019  
LP0988 | Revision B

## **COPYRIGHT**

©2019 Red Lion Controls, Inc. All rights reserved. Red Lion, the Red Lion logo, N-Tron and N-Ring are registered trademarks of Red Lion Controls, Inc. All other company and product names are trademarks of their respective owners.

Red Lion Controls, Inc.  
20 Willow Springs Circle  
York, PA 17406

## **CONTACT INFORMATION:**

Inside US: +1 (877) 432-9908  
Outside US: +1 (717) 767-6511

Website: [www.redlion.net](http://www.redlion.net)

Support: [support.redlion.net](http://support.redlion.net)

## Table of Contents

<b>Preface</b> .....	iv
Disclaimer .....	iv
Compliance Information .....	iv
Part 15 of the Federal Communications Commission (FCC) - A Rules: Interference .....	iv
Déclaration de conformité FCC .....	iv
Industry Canada .....	v
Environmental Impact Statement .....	v
Toxic Emissions .....	v
Trademark Acknowledgments .....	v
Release Notes and Document Updates .....	v
Publication History .....	v
Related Documents .....	vi
Document Comments .....	vi
Additional Product Information .....	vi
Cautions and Warnings / Mises en Garde et Avertissements .....	vi
General Safety Cautions and Warnings / Précautions et Avertissements de Sécurité Générale .....	vi
KC Mark (Korea) .....	vii
Electrical Safety Warnings / Avertissements de Sécurité électrique .....	vii
Environmental Safety Cautions and Warnings / Sécurité Environnementale Mises en Garde et Avertissements .....	viii
Hazardous Location Warnings / Les Avertissements d'Emplacement Dangereux .....	ix
Laser Safety Warnings / Avertissements de Sécurité Laser .....	x
Regulatory Certifications and Approvals .....	xi
<b>Chapter 1 Product Overview</b> .....	1-1
1.1 Common Features .....	1-1
1.1.1 Connectivity .....	1-1
1.1.2 Performance .....	1-1
1.1.3 Environmental .....	1-1
1.1.4 Monitoring .....	1-1
1.1.5 Security .....	1-1
1.2 Available Models .....	1-2
1.3 709FX .....	1-3
1.3.1 Features and Benefits .....	1-3
1.3.2 709FX Specifications .....	1-4
1.3.3 709FX Dimensions .....	1-5
1.3.4 709FX-HV Dimensions .....	1-6
1.4 710FX2 .....	1-7
1.4.1 Features and Benefits .....	1-7
1.4.2 710FX2 Specifications .....	1-8
1.4.3 710FX2 Dimensions .....	1-9
1.4.4 710FX2-HV Dimensions .....	1-10
1.5 711FX3 .....	1-11
1.5.1 Features and Benefits .....	1-11
1.5.2 711FX3 Specifications .....	1-12
1.5.3 711FX3 Dimensions .....	1-13
1.5.4 711FX3-HV Dimensions .....	1-14
1.6 712FX4 .....	1-15



- 1.6.1 Features and Benefits . . . . . 1-15
- 1.6.2 712FX4 Specifications . . . . . 1-16
- 1.6.3 712FX4 Dimensions . . . . . 1-17
- 1.6.4 712FX4-HV Dimensions . . . . . 1-18
- 1.7 714FX6 . . . . . 1-19
  - 1.7.1 Features and Benefits . . . . . 1-19
  - 1.7.2 714FX6 Specifications . . . . . 1-20
  - 1.7.3 714FX6 Dimensions . . . . . 1-21
- 1.8 7010TX . . . . . 1-22
  - 1.8.1 Features and Benefits . . . . . 1-22
  - 1.8.2 7010TX Specifications . . . . . 1-23
  - 1.8.3 7010TX Dimensions . . . . . 1-24
- 1.9 7012FX2 . . . . . 1-25
  - 1.9.1 Features and Benefits . . . . . 1-25
  - 1.9.2 7012FX2 Specifications . . . . . 1-26
  - 1.9.3 7012FX2 Dimensions . . . . . 1-27
- 1.10 7026TX . . . . . 1-28
  - 1.10.1 Features and Benefits . . . . . 1-28
  - 1.10.2 7026TX Specifications . . . . . 1-29
  - 1.10.3 7026TX Dimensions . . . . . 1-30
- 1.11 7506GX2 . . . . . 1-31
  - 1.11.1 Features and Benefits . . . . . 1-31
  - 1.11.2 7506GX2 Specifications . . . . . 1-32
  - 1.11.3 7506GX2 Dimensions . . . . . 1-33
- 1.12 7900 . . . . . 1-34
  - 1.12.1 Features and Benefits . . . . . 1-34
  - 1.12.2 7900 Specifications . . . . . 1-35
  - 1.12.3 7900 Dimensions . . . . . 1-36
- 1.13 Optional Panel Mount . . . . . 1-37
  - 1.13.1 Panel Mount Application . . . . . 1-37
  - 1.13.2 Compact Panel Mount CPMA-1 Dimensions . . . . . 1-38
  - 1.13.3 Compact Panel Mount CPMA-2 Dimensions . . . . . 1-39
  - 1.13.4 Panel Mount 9000-PM Dimensions . . . . . 1-40
- 1.14 Transceiver Characteristics . . . . . 1-41
  - 1.14.1 100 MB Fiber Transceiver Characteristics . . . . . 1-41
  - 1.14.2 Gigabit Fiber Transceiver (SFP) Characteristics . . . . . 1-41
- 1.15 LEDs . . . . . 1-42
- 1.16 Ordering Guide . . . . . 1-43
  - 1.16.1 709FX . . . . . 1-43
  - 1.16.2 710FX2 . . . . . 1-44
  - 1.16.3 711FX3 . . . . . 1-45
  - 1.16.4 712FX4 . . . . . 1-46
  - 1.16.5 714FX6 . . . . . 1-47
  - 1.16.6 7010TX . . . . . 1-48
  - 1.16.7 7012FX2 . . . . . 1-49
  - 1.16.8 7026TX . . . . . 1-50
  - 1.16.9 7506GX2 . . . . . 1-51
  - 1.16.10 7900 . . . . . 1-52



<b>Chapter 2 Hardware Installation</b> .....	2-53
2.1 Unpacking .....	2-53
2.2 Mounting the Switch .....	2-53
2.3.1 DIN-Rail Mounting Instructions 709FX, 710FX2, 711FX3, 712FX4, 714FX6, 7010TX, 7012FX2, 7506GX2, and 7900 Models .....	2-53
2.3.2 DIN-Rail Removal Instructions 709FX, 710FX2, 711FX3, 712FX4, 714FX6, 7010TX, 7012FX2, and 7506GX2 Models .....	2-54
2.3.3 DIN-Rail Removal Instructions 7900 Model .....	2-55
2.3.4 Rack and Panel Mounting Instructions 709FX, 710FX2, 711FX3, 712FX4, 714FX6, 7010TX, 7012FX2, 7506GX2, and 7900 Models .....	2-55
Rack Mounting 709FX, 710FX2, 711FX3, 712FX4, 714FX6, 7010TX, 7012FX2, 7506GX2, and 7900 Models .....	2-56
Panel Mounting 709FX, 710FX2, 711FX3, 712FX4, 714FX6, 7010TX, 7012FX2, 7506GX2, and 7900 Models .....	2-56
2.3.5 Rack and Panel Mounting Instructions for 7026TX Model .....	2-57
Rack Mounting 7026TX Model .....	2-57
Panel Mounting 7026TX Model .....	2-58
2.4 Connect Power Source .....	2-59
2.4.1 709FX, 710FX2, 711FX3, 712FX4, 714FX6, 7010TX, and 7012FX2 Models .....	2-59
2.4.2 7026TX .....	2-60
2.4.3 7026TX-AC .....	2-60
2.4.4 7506GX2 .....	2-61
2.4.5 7900 .....	2-62
2.5 Grounding the Switch .....	2-63
2.5.1 Grounding 709FX, 710FX2, 711FX3, 712FX4, 714FX6, 7010TX, and 7012FX2 Models .....	2-63
2.5.2 Grounding 7026TX and 7026TX -AC Models .....	2-64
2.5.3 Grounding 7506GX2 .....	2-65
2.5.4 Grounding 7900 Models .....	2-66
2.6 Connecting the Switch .....	2-67
2.6.1 Connecting 709FX, 710FX2, 711FX3, 712FX4, 714FX6, 7010TX, 7012FX2, 7026TX, and 7900 Models .....	2-67
2.6.2 Connecting 7506 Models .....	2-67
Connect the Ethernet Cable .....	2-68
RJ45 Connector Crimp Specifications .....	2-69
2.6.3 Serial Interface (7900) .....	2-69
Serial Cable Connection (7900) .....	2-69
2.6.4 HyperTerminal Terminal Interface .....	2-70
2.6.5 USB Interface .....	2-70
USB Cable .....	2-70
2.7 Fault Pins .....	2-71
2.8 Configuration Devices .....	2-71
2.8.1 NTCD-128 SD Card Configuration Device .....	2-71
2.9 Cleaning .....	2-71
2.10 Troubleshooting .....	2-72
2.11 Servicing (7900) .....	2-72
2.11.1 Adding or Replacing a Module .....	2-72
2.11.2 Replacing a CPU Module .....	2-73
 <b>Chapter 3 Accessing the Web Software Interface</b> .....	 3-74



# Preface

## Disclaimer

Portions of this document are intended solely as an outline of methodologies to be followed during the installation maintenance and operation of N-Tron® Series 700 and 7000 models switch equipment. It is not intended as a step-by-step guide or a complete set of all procedures necessary and sufficient to complete all operations.

While every effort has been made to ensure that this document is complete and accurate at the time of release, the information that it contains is subject to change. Red Lion Controls is not responsible for any additions to or alterations of the original document. Industrial networks vary widely in their configurations, topologies, and traffic conditions. This document is intended as a general guide only. It has not been tested for all possible applications, and it may not be complete or accurate for some situations.

Users of this document are urged to heed warnings and cautions summarized at the front of the document, such as electrical hazard warnings.

## Compliance Information

It is recommended that the owner of this equipment determine and ensure conformance with any specific and applicable local regulations.

### Part 15 of the Federal Communications Commission (FCC) - A Rules: Interference

Every effort has been made to ensure that this equipment is designed to comply with the limits for a Class A digital device, as described in the FCC Rules.

This product complies with Part 15 of the FCC-A Rules.

Operation is subject to the following conditions:

1. This device may not cause harmful Interference
2. This device must accept any interference received, including interference that may cause undesired operation.

**Note** - This equipment has been tested and found to comply with the limits for a Class A digital device, pursuant to Part 15 of the FCC Rules. These limits are designed to provide reasonable protection against harmful interference in a residential installation. This equipment generates, uses, and can radiate radio frequency energy and, if not installed and used in accordance with the instructions, may cause harmful interference to radio communications. Operation of this device in a residential area is likely to cause harmful interference in which case the user will be required to correct the interference at their own expense.

### Déclaration de conformité FCC

Ce produit est conforme à la partie 15 des règles de la FCC -A

Utilisation est soumise aux conditions suivantes:

1. Ce dispositif ne doit pas causer des interférences nuisibles
2. Cet appareil doit accepter toute interférence reçue, y compris les interférences qui peuvent causer un mauvais fonctionnement.



**Note:** Cet équipement a été testé et jugé conforme aux limites de la classe A des appareils numériques, conformément à la partie 15 des règles de la FCC. Ces limites sont conçues pour fournir une protection raisonnable contre les interférences nuisibles dans une installation résidentielle. Cet équipement génère, utilise et peut émettre de l'énergie radiofréquence et, si il n'est pas installé et utilisé conformément aux instructions, peut causer des interférences nuisibles aux communications radio. L'utilisation de cet appareil dans une zone résidentielle est susceptible de provoquer des interférences nuisibles, auquel cas l'utilisateur sera tenu de corriger les interférences à ses propres frais.

### **Innovation, Science and Economic Development Canada**

This Class A digital apparatus meets all requirements of the CAN ICES-003. Operation is subject to the following two conditions; (1) this device may not cause harmful interference, and (2) this device must accept any interference received, including interference that may cause undesired operation.

Cet appareillage numérique de la classe A répond à toutes les exigences de CAN ICES-003. L'opération est sujette aux deux conditions suivantes: (1) ce dispositif peut ne pas causer l'interférence nocive, et (2) ce dispositif doit accepter n'importe quelle interférence reçue, y compris l'interférence qui peut causer l'opération peu désirée.

### **Environmental Impact Statement**

Red Lion equipment contains no hazardous materials as defined by the United States Environmental Protection Agency (USEPA). Red Lion recommends that all failed product be returned to Red Lion for failure analysis and proper disposal.

### **Toxic Emissions**

Red Lion equipment releases no toxic emissions.

### **Trademark Acknowledgments**

Ethernet™ is a registered trademark of Xerox Corporation.

EtherNet/IP™ and CIP™ are registered trademarks of ODVA™.

All other company and product names are trademarks of their respective owners.

### **Release Notes and Document Updates**

The hard copy and electronic media versions of this document are revised only at major releases and therefore, may not always contain the latest product information. As needed, Documentation Notes and or Product Bulletins will be provided between major releases to describe any new information or document changes.

The latest online version of this document and all product updates can be accessed through the Red Lion web site at <http://www.redlion.net>

### **Publication History**

The following information lists the release history of this document.

Issue/Revision	Release Date	Content Description
Initial release	January 2019	Initial document release combining 700/7000 switch models





## Related Documents

This Hardware Manual (Volume II) covers the following 700/7000 product models:

709FX 710FX2 711FX3 712FX4 714FX6 7010TX 7012FX2 7026TX 7506GX2 7900

Hardware Manual (Volume I) covers the following 700/7000 models:

708TX 708FX2 716TX 716FX2 708M12 716M12 7018TX 7018FX2

Visit the Technical Resources page on the Red Lion website at the following link to view available documents related to this product.

[www.redlion.net](http://www.redlion.net)

## Document Comments

Red Lion appreciates all comments that will help us to improve our documentation quality. The user can submit comments through the Red Lion Customer Service. Simply email us at [support@redlion.net](mailto:support@redlion.net).

## Additional Product Information

Additional product information can be obtained by contacting the local sales representative or Red Lion through the contact numbers and/or e-mail addresses listed on the inside of the front cover.

## Cautions and Warnings / Mises en Garde et Avertissements



Warnings apply to situations where personal injury or death may result.



Mises en garde s'appliquent aux situations où les risques de blessures graves ou mortelles peuvent en résulter.

Cautions apply to where reduced function or damage to equipment may result.

Les mises en garde s'appliquent à où une fonction réduite ou d'endommagement de l'équipement peut entraîner.

### General Safety Cautions and Warnings / Précautions et Avertissements de Sécurité Générale

	<p><b>CAUTION:</b> If the equipment is used in the manner not specified by Red Lion, the protection provided by the equipment may be impaired.</p> <p><b>ATTENTION:</b> Si l' équipement est utilisé d'une manière non spécifiée par Red Lion, la protection fournie par l'équipement peut être compromise.</p>
	<p><b>CAUTION:</b> Do not block any air vents on the unit.</p> <p><b>ATTENTION:</b> N'obstruez pas les fentes d'aération de l'unité.</p>



	<p><b>CAUTION:</b> Do not operate the equipment in a manner not specified by this manual.</p> <p><b>ATTENTION:</b> Ne pas faire fonctionner l'équipement d'une manière non spécifiée par ce manuel.</p>
	<p><b>WARNING:</b> Install only in accordance with Local and National Codes of authorities having jurisdiction.</p> <p><b>AVERTISSEMENT:</b> Installer uniquement, conformément aux codes locaux et nationaux des autorités ayant compétence.</p>

### KC Mark (Korea)

**Note:** Model 7900 Series only.

<p>A 급 기기 (업무용 방송통신 기자재)</p> <p><b>Class A device</b> (Broadcasting and communication equipments for office work)</p>	<p>이기는 업무용(A급) 전자파 적합기기로서 판매자 또는 사용자는 이 점을 주의하시기 바라며, 가정 외 지역에서 사용하는 것을 목적으로 합니다.</p> <p>This equipment is office use (Class A) electromagnetic wave suitability equipment and seller or user should take notice of it, and this equipment is to be used in the places except for home.</p>
---	---

### Electrical Safety Warnings / Avertissements de Sécurité Électrique

	<p><b>WARNING:</b> Never install or work on electrical equipment or cabling during periods of lightning activity.</p> <p><b>AVERTISSEMENT</b> - Ne jamais installer ou travailler sur équipement électrique ou de câblage pendant les périodes d'activité de la foudre.</p>
	<p><b>CAUTION:</b> Do not perform any services on the unit unless qualified to do so. Do not substitute unauthorized parts or make unauthorized modifications to the unit.</p> <p><b>ATTENTION:</b> Ne pas effectuer de services sur l'appareil s'il n'est pas qualifié pour le faire. Ne pas substituer pièces non autorisées ou de modifications non autorisées de l'appareil.</p>
	<p><b>WARNING:</b> Properly ground the unit before connecting anything else to the unit. Units not properly grounded may result in a safety risk and could be hazardous and may void the warranty. See the grounding technique section of this manual for proper ways to ground the unit.</p> <p><b>AVERTISSEMENT:</b> L'unité doit être correctement mise à la terre avant tout raccordement à l'unité. Unités pas correctement mise à la terre peuvent causer un risque de sécurité et pourraient être dangereuses et peuvent annuler la garantie. Voir la section technique de mise à la terre dans ce mode d'emploi pour des moyens appropriés à la masse de l'appareil.</p>



**WARNING:** Power must be supplied by an isolating source and a UL-rated in-line 2.5A fuse must be installed immediately before the unit.

**AVERTISSEMENT:** Celui-ci doit être alimenté par une source d'isolement et une homologués UL en-ligne fusible 2,5A doit être installé immédiatement avant l'unité.



**WARNING:** Must be used with a Listed UL Industrial Power Supply. Models 709FX, 710FX2, 711FX3, 712FX4, 714FX6, 7010TX, 7012FX2 and 7026TX must be powered by a Class 2 source only.

**AVERTISSEMENT:** Doit être utilisé avec une alimentation industrielle répertorié UL. Les modèles 709FX, 710FX2, 711FX3, 712FX4, 714FX6, 7010TX, 7012FX2 et 7026TX doit être alimenté par une source de classe 2 uniquement.



**WARNING:** Do not service the equipment without first disconnecting the power connector.

**AVERTISSEMENT:** Ne pas effectuer l'entretien de l'équipement sans avoir préalablement débranché le connecteur d'alimentation.



**WARNING:** Do not operate the unit with any cover removed, as this could create a shock or fire hazard.

**AVERTISSEMENT:** Ne pas faire fonctionner l'unité avec un capot enlevé, car cela pourrait créer une décharge électrique ou un incendie.



**CAUTION:** Observe proper DC Voltage polarity when installing power input cables. Reversing voltage polarity can cause permanent damage to the unit and void the warranty.

**ATTENTION:** Respectez la polarité correcte de tension DC lors de l'installation des câbles d'alimentation d'entrée. Inversion de polarité de tension peut causer des dommages permanents à l'appareil et annule la garantie.

## Environmental Safety Cautions and Warnings / Sécurité Environnementale Mises en Garde et Avertissements



**WARNING:** Do not operate the equipment in the presence of flammable gases or fumes. Operating electrical equipment in such an environment constitutes a definite safety hazard.







**AVERTISSEMENT :** Ne pas utiliser le matériel en présence de gaz ou de vapeurs inflammables. L'utilisation de matériel électrique dans un tel environnement constitue un danger certain.





**WARNING:** Disconnect the power and allow to cool 5 minutes before touching.

**AVERTISSEMENT:** Déconnectez le câble d'alimentation et laissez refroidir 5 minutes avant de la toucher.

## Hazardous Location Warnings / Les Avertissements d'Emplacement Dangereux

	<p><b>CAUTION:</b> This equipment is suitable for use in Class I, Division 2, Groups A, B, C, and D or non-hazardous locations only. Combinations of equipment in your system are subject to investigation by the local authority having jurisdiction at the time of installation.</p> <p><b>ATTENTION:</b> Cet appareil est adapté pour utilisation en Classe I, Division 2, Groupes A, B, C, D ou endroits non-dangereux seulement. Combinaisons d'équipements de votre système sont objet d'une enquête par l'autorité locale compétente au moment de l'installation.</p>
	<p><b>CAUTION:</b> These devices are open-type devices that are to be installed in an enclosure suitable for the environment.</p> <p><b>ATTENTION:</b> C'est appareils sont type ouvert et doivent être installés dans un boîtier adapté à l'environnement.</p>
	<p><b>WARNING:</b> Explosion Hazard – Substitution of components may impair suitability for Class I, Division 2.</p> <p><b>AVERTISSEMENT</b> - Risque d'explosion - La substitution de tout composant peut nuire à la conformité de Classe 1, Division 2.</p>
	<p><b>WARNING:</b> Explosion Hazard – Do not connect or disconnect any connections while circuit is live unless area is known to be non-hazardous.</p> <p><b>AVERTISSEMENT:</b> Risque d'explosion - Ne pas brancher ou débrancher les connexions lorsque le circuit est sous tension sauf si la zone est connue pour être non dangereuse.</p>
	<p><b>WARNING:</b> Explosion Hazard – Do not remove or replace the Ethernet or fiber optic transceivers unless power has been disconnected or the area is known to be free of ignitable concentrations of flammable gases or vapors. This marking shall be displayed in a prominent place on the end-enclosure.</p> <p><b>AVERTISSEMENT:</b> Risque d'explosion - Ne pas enlever ou remplacer l'Ethernet ou des émetteurs-récepteurs pour fibre optique à moins que l'alimentation a été débranché ou la zone est connu pour être à l'abri de des concentrations de gaz ou vapeurs inflammables. Cette marque doit être affichée dans un endroit bien en vue sur l'enceinte.</p>
	<p><b>WARNING:</b> Exposure to some chemicals may degrade the sealing properties of materials used in the Sealed Relay Device. Relays U13 and U25 on models 709FX, 710FX2, 711FX3, 712FX4, 714FX6, 7010TX and 7012FX2 only. Relay U25 on model 7026TX.</p> <p><b>AVERTISSEMENT:</b> L'exposition à certains produits chimiques risquent de dégrader l'étanchéité des propriétés des matériaux utilisés dans l'appareil relais étanche. Relais U13 et U25 sur les modèles 709FX, 710FX2, 711FX3, 712FX4, 714FX6, 7010TX et 7012FX2 uniquement. Relais U25 sur le modèle 7026TX.</p>
	<p><b>WARNING:</b> Explosion Hazard – Do not replace the device unless power has been switched off or the area is known to be non-hazardous.</p> <p><b>AVERTISSEMENT:</b> Risque d'explosion - Ne pas remplacer l'appareil à moins que l'alimentation a été coupée ou que la zone est connue pour être non-dangereuse.</p>

	<p><b>WARNING:</b> Disconnect the power cable before removing any enclosure panel.</p> <p><b>AVERTISSEMENT:</b> Débrancher le câble d'alimentation avant de retirer tout panneau de boîtier.</p>
	<p><b>Note:</b> Use 90 °C or higher rated copper wire, 0.22 Nm 2lb/in tightening torque for field installed conductors for 709FX, 710FX2, 711FX3, 712FX4, 714FX6, 7010TX, 7012FX2, 7506GX2 and 7900 models.</p> <p><b>Remarque:</b> l'utilisation de 90 °C ou plus classé le fil de cuivre, 0,22 Nm 2lb/de couple de serrage pour conducteurs pour 709FX, 710FX2, 711FX3, 712FX4, 714FX6, 7010TX, 7012FX2, 7506GX2 et 7900 modeles.</p>
	<p><b>Note:</b> Use 105 °C or higher rated copper wire, 0.22 Nm 2lb/in tightening torque for field installed conductors for 7026TX models.</p> <p><b>Remarque:</b> l'utilisation de 105 °C ou plus classé le fil de cuivre, 0,22 Nm 2lb/de couple de serrage pour conducteurs pour 7026TX modeles..</p>

### Laser Safety Warnings / Avertissements de Sécurité Laser

	<p><b>CAUTION:</b> CLASS 1 LASER PRODUCT. Do not stare into the laser.</p> <p><b>ATTENTION:</b> PRODUIT LASER CLASSE 1. Ne pas regarder dans le laser.</p>
--	--

**Note:** Laser safety must be observed with the following models having lasers present: 709FX Models -40, -80; 710FX2 Models -40, -80; 711FX3 Models -40, -80; 712FX4 Models -40, -80; 714FX6 Models -40, -80; 7010TX Models (and optional NTSFP-LX -40 and -80); 7012FX2 Models -40, -80 (and optional NTSFP-LX -40 and -80); 7026TX Models (and optional NTSFP-LX -40 and -80); 7506GX2 Models (and optional NTSFP-LX -40 and -80); and 7900 Models (and optional NTSFP-LX -40 and -80).

**Remarque:** La sécurité laser doit être observé avec les modèles lasers ayant présents: Les modèles 709FX -40, -80; modèles 710FX2-40, -80; modèles 711FX3 -40, -80; modèles 712FX4 -40, -80; modèles 714FX6 -40, -80; modèles 7010TX (et en option NTSFP-LX -40 et -80); les modèles 7012FX2 -40, -80 (et en option NTSFP-LX -40 et -80); 7026TX modèles (et en option NTSFP-LX -40 et -80) ; les modèles 7506GX2 (et en option NTSFP-LX -40 et -80) ; et les modèles 7900 (et en option NTSFP-LX -40 et -80).

## Regulatory Certifications and Approvals

Specification/Model	709FX	709FX-HV	710FX2	710FX2 -HV	711FX3	711FX3 -HV	712FX4	712FX4 -HV	714FX6	7010TX	7012FX2	7012FX2 -HV	7026TX	7506GX2	7900
<b>Product Safety</b>															
UL 508, ANSI/ISA-12.12.01, Nonincendive Electrical Equipment for Use in Class I and II, Division 2 and Class III, Division 1 and 2 Hazardous (Classified) Locations, or Non-Hazardous Locations Only.	X		X		X		X		X	X	X		X	X	X
CAN/CSA-C22.2 No. 14 or 142; CAN/CSA-C22.2 N0. 213	X		X		X		X		X	X	X		X	X	X
TUV/GS EN 60950-1, AfPS GS 2014		X		X		X		X				X			
<b>EMI</b>															
ANSI C63.4, FCC 47 CFR Part 15, Subpart B - Class A, ICES-003	X	X	X	X	X	X	X	X	X	X	X	X	X	X	X
EN 61000-6-4 (Emissions)	X	X	X	X	X	X	X	X	X	X	X	X	X	X	X
EN 61000-3-2/3 (Emissions)													X		
EN 55022 (Emissions)													X		
<b>EMC</b>															
EN 61000-6-2 (Immunity)	X	X	X	X	X	X	X	X	X	X	X	X	X	X	X
EN 55024 (Immunity)													X		
EN/IEC 61000-4-2 (ESD)	X	X	X	X	X	X	X	X	X	X	X	X	X	X	X
EN/IEC 61000-4-3 (RFI)	X	X	X	X	X	X	X	X	X	X	X	X	X	X	X
EN/IEC 61000-4-4 (EFT)	X	X	X	X	X	X	X	X	X	X	X	X	X	X	X
EN/IEC 61000-4-5 (Surge)	X	X	X	X	X	X	X	X	X	X	X	X	X	X	X
EN/IEC 61000-4-6 (RF)	X	X	X	X	X	X	X	X	X	X	X	X	X	X	X
EN/IEC 61000-4-8 (PF)	X	X	X	X	X	X	X	X	X	X	X	X	X	X	X
EN/IEC 61000-4-11 (Voltage Dips)	X		X		X		X		X	X	X		X	X	X
EMC Directive 2014/30/EU	X	X	X	X	X	X	X	X	X	X	X	X	X	X	X
<b>Environmental</b>															
IEC 61850-3 Electric Utility Substations		X		X		X		X				X			
IEEE 1613 Electric Utility Substations		X		X		X		X				X			X
Designed to comply with IEEE 1613 Electric Utility Substations	X		X		X		X		X	X	X		X	X	X



Specification/Model	709FX	709FX-HV	710FX2	710FX2 -HV	711FX3	711FX3 -HV	712FX4	712FX4 -HV	714FX6	7010TX	7012FX2	7012FX2 -HV	7026TX	7506GX2	7900
Designed to comply with NEMA TS1/TS2 Traffic Control	x	x	x	x	x	x	x	x	x	x	x	x	x	x	x
ABS (PDA and Type Approval for Shipboard Applications)															x
<b>Other</b>															
RoHS 2 Directive 2011/65/EU	x	x	x	x	x	x	x	x	x	x	x	x	x	x	x
RoHS 3 Directive (EU) 2015/863*	x	x	x	x	x	x	x	x	x	x	x	x	x	x	x
Low Voltage Directive 2014/35/EU	x	x	x	x	x	x	x	x	x	x	x	x	x	x	x

\* Effective 22 July 2019



# Chapter 1 Product Overview

## 1.1 Common Features

Red Lion's N-Tron<sup>®</sup> series 700/7000 managed Industrial Gigabit Ethernet switches offer a wide array of port configurations and media types. See "Available Models" on page 2. for a list of the 700/7000 models covered in this document. Refer to Hardware Manual Volume I, document LP0988 for other available 700/7000 models. Please see the 700/7000 Software Manual, document LP0985, for more information on device configuration and operation.

All 700/7000 switches offer plug-and-play installation with IGMP support, media/port auto-detection and simple ring configuration, making the 700/7000 platform one of the easiest to deploy managed industrial Ethernet switches in the industry. Housed in rugged hardened enclosures, the 700/7000 switches feature extended shock and vibration specifications, wide operating temperature ratings and best-in-class ring technology.

### 1.1.1 Connectivity

The 700/7000 fully managed Ethernet switch models offer a wide array of port configurations and media types with 10/100 copper, as well as Fast Ethernet and Gigabit fiber options. For maximum flexibility, the models are available with copper only ports or a mix of copper and fiber ports.

### 1.1.2 Performance

700/7000 managed switches provide uncompromising performance in harsh environments, including network features like N-Ring<sup>™</sup>, VLAN, Quality of Service (QoS), port mirroring, IGMP, and SNMP. Additionally the 700/7000 offers full IEEE 802.3 compliance. These network management features provide best-in-class visibility, security and uptime performance.

### 1.1.3 Environmental

The ultra-reliable 700/7000 fully managed industrial Ethernet switches are DIN-Rail mountable and offer operating temperatures up to -40 °C to 80 °C. With UL Class I, Division 2 listing, and CE certifications, these industrial switches are built to last in the most demanding and hazardous environments.

### 1.1.4 Monitoring

The N-View<sup>™</sup> monitoring technology provided with the switch provides different status points on switch and port conditions and displays that information on any networked computer.

### 1.1.5 Security

The 700/7000 models provide a high level of security utilizing IEEE 802.3 and SNMPv3 communication protocol to ensure the safest networks.





## 1.2 Available Models

Part #	Total Ports	Mounting	Operating Temperature	10/100 TX RJ45 Copper Ports	100 FX Ports	SFPs**	Redundant Power Input	HV Option Power Input
709FX	9	DIN-Rail	-40 °C to 70 °C	8	1	-	10-49 VDC	43-300 VDC*
710FX2	10	DIN-Rail	-40 °C to 70 °C	8	2	-	10-49 VDC	43-300 VDC*
711FX3	11	DIN-Rail	-40 °C to 70 °C	8	3	-	10-49 VDC	43-300 VDC*
712FX4	12	DIN-Rail	-40 °C to 70 °C	8	4	-	10-49 VDC	43-300 VDC*
714FX6	14	DIN-Rail	-40 °C to 70 °C	8	6	-	10-49 VDC	-
7010TX	10	DIN-Rail	-40 °C to 70 °C	8	-	Up to 2	10-49 VDC	-
7012FX2	12	DIN-Rail	-40 °C to 70 °C	8	2	Up to 2	10-49 VDC	43-300 VDC*
7026TX	26	Rackmount	-40 °C to 80 °C	24	-	Up to 2	18-49 VDC	-
7026TX-AC	26	Rackmount	-40 °C to 80 °C	24	-	Up to 2	90-264 VAC	90-300 VDC*
7506GX2	6	DIN-Rail	-40 °C to 80 °C	4***	-	Up to 2	10-49 VDC	-
7900 (4 Slot Modular Switch)	26	DIN-Rail	-20 °C to 70 °C	Up to 24	Up to 16	Up to 2	10-30 VDC	-

\* Optional

\*\* See ["Gigabit Fiber Transceiver \(SFP\) Characteristics"](#) on page 41 for available Gigabit SFP transceivers.

\*\*\* 10/100/1000 TX RJ45 Copper Ports



## 1.3 709FX

The versatile 709FX Industrial Ethernet switch is a fully managed switch that features eight 10/100 BaseTX RJ45 copper ports and one 100Base ST or SC fiber port housed in a hardened metal DIN-Rail enclosure with redundant 10-49 VDC power inputs (HV 43-300 VDC available). Designed to handle the most demanding environments. The 709FX offers expanded shock and vibration ratings and wide -40 °C to 70 °C operating temperature rating. The 709FX combines outstanding performance and ease of use. The fully managed switch is ideally suited for use in industrial applications such as factory floor control networks, utilities, transportation applications and any other application where high reliability, and extended distance are required.

### 1.3.1 Features and Benefits

#### Features and Benefits

Full IEEE 802.3 Compliance  
 Eight 10/100 Base-T(X) RJ45 Copper Ports  
 One 100BaseFX(E) Port  
 Redundant 10 to 49 VDC Power Inputs
 

- Keeps network running in the event of a power supply failure.
- HV High Voltage Option (43-300VDC)

 -40°C to 70 °C operating temperature  
 ESD and Surge Protection Diodes on all Ports  
 Autosensing 10/100BaseTX, Duplex, and MDIX  
 Offers Rapid Spanning Tree Protocol  
 Trunk with other N-Tron trunking capable switches over two ports  
 Store & Forward Technology  
 Plug-and-Play IGMP Support  
 Rugged DIN-Rail Enclosure  
 Onboard Temperature Sensor  
 Configuration Backup via optional SD Card (NTCD-128)  
 SNMP v1, v2 and v3  
 Web Browsing and N-View Switch Monitoring  
 Configurable Alarm Contact  
 Configurable Bi-Color Fault Status LED

#### Fully Managed Features Include:

- Full SNMP and Web Browser Management
- Detailed Ring Map and Fault Location Charting
- IGMP
- N-Ring™ Technology with ~30ms Healing
- N-View™ OPC Monitoring
- N-Link™ Redundant N-Ring Coupling
- 802.1Q VLAN Tagging and Port VLAN
- 802.1p QoS, Port QoS, and DSCP
- 802.1D RSTP (Rapid Spanning Tree Protocol)
- Ethernet/IP™ CIP Messaging
- LLDP (Link Layer Discovery Protocol)
- Trunking
- Port Mirroring
- DHCP Client, Server, Option 82 relay, Option 61, IP Fallback
- Local Port IP Addressing
- Port Security-MAC Address Based



\* HV Models Only



### 1.3.2 709FX Specifications

Mechanical				
Height	Width	Depth	Weight	Mount
4.3" (10.8 cm)	2.4" (6.1 cm) 3.1" (7.9 cm) *	4.6" (11.7 cm)	1.4 lbs (0.64 kg) 1.6 lbs (0.73 kg) *	35mm DIN-Rail
Power Input				
Input Voltage	Steady Input Current	BTU/hr		
10-49 VDC (Regulated)	365 mA @ 24 VDC	29.89 @ 24 VDC		
43-300 VDC (Regulated)*	80 mA @ 124 VDC*	34 @ 124 VDC*		
Environmental				
Operating Temperature	Storage Temperature	Operating Humidity		Operating Altitude
-40 °C to 70 °C	-40 °C to 85 °C	5% to 95% (non condensing)		0 to 10,000 ft.
Shock and Vibration				
Shock	Vibration		Note	
200g @ 10 ms	50g, 5-200Hz, Triaxial		Unit must be bulkhead mounted to achieve these levels.	
Connectors				
10/100BaseTX: Eight RJ45 copper ports 100BaseFX: One SC or ST duplex fiber port				
Recommended Minimum Wiring Clearance				
Top	1" (2.54 cm)			
Front	4" (10.16 cm)			
Bottom	1" (2.54 cm)			
Network Media				
10BaseT	100BaseTX	100BaseFX	100BaseFXE	
≥CAT3 Cable	≥CAT5 Cable	Multimode: 50-62.5/125µm	Singlemode: 7-10/125µm	
Switch Properties				
Number of MAC Addresses		Aging Time	Latency (Typical)	Switching Method
8,000		Programmable	2.6 µs	Store & Forward

Refer to "100 MB Fiber Transceiver Characteristics"

\* High voltage option



### 1.3.3 709FX Dimensions

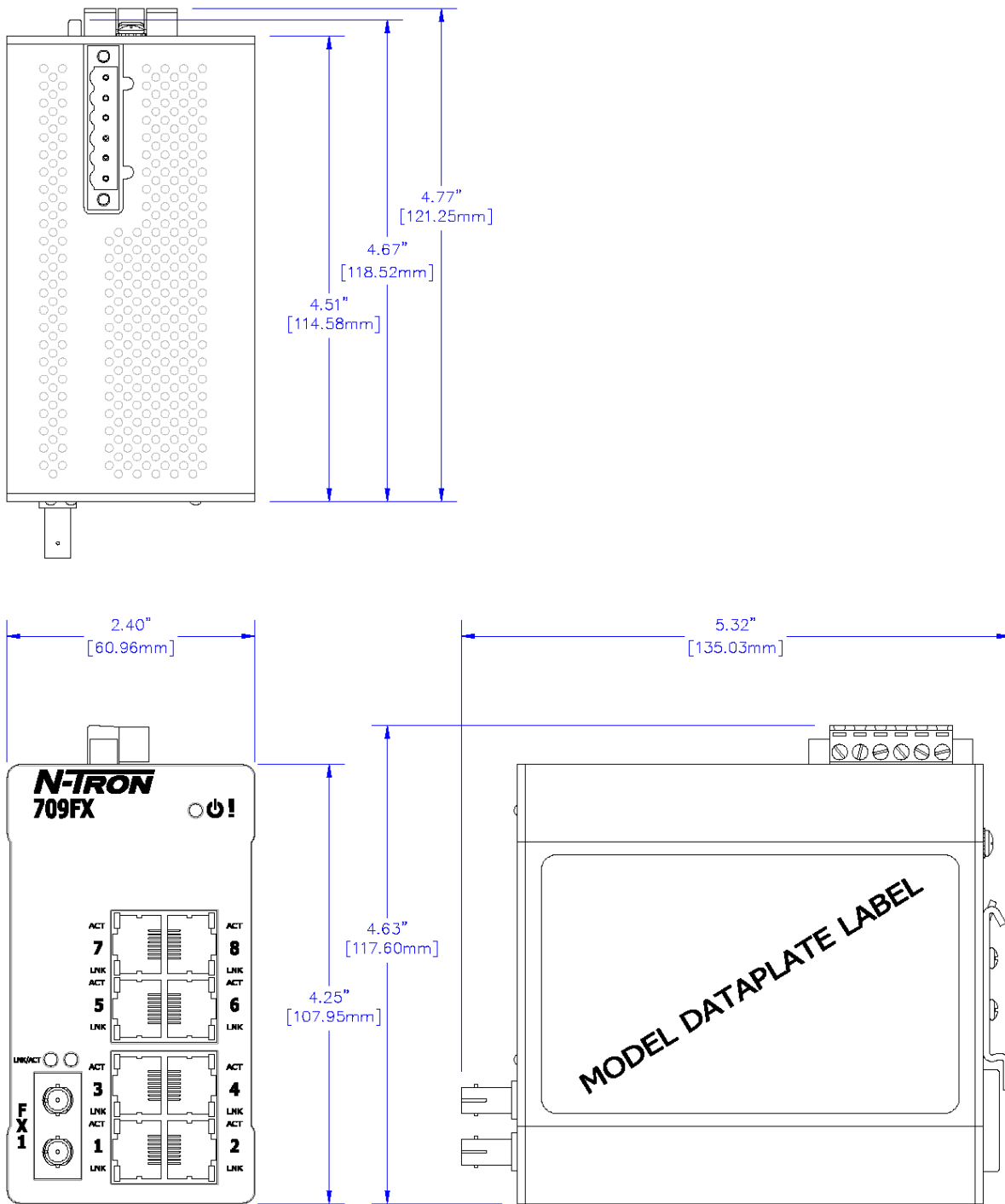

All specifications are subject to change. Consult the company website for more information.



### 1.3.4 709FX-HV Dimensions

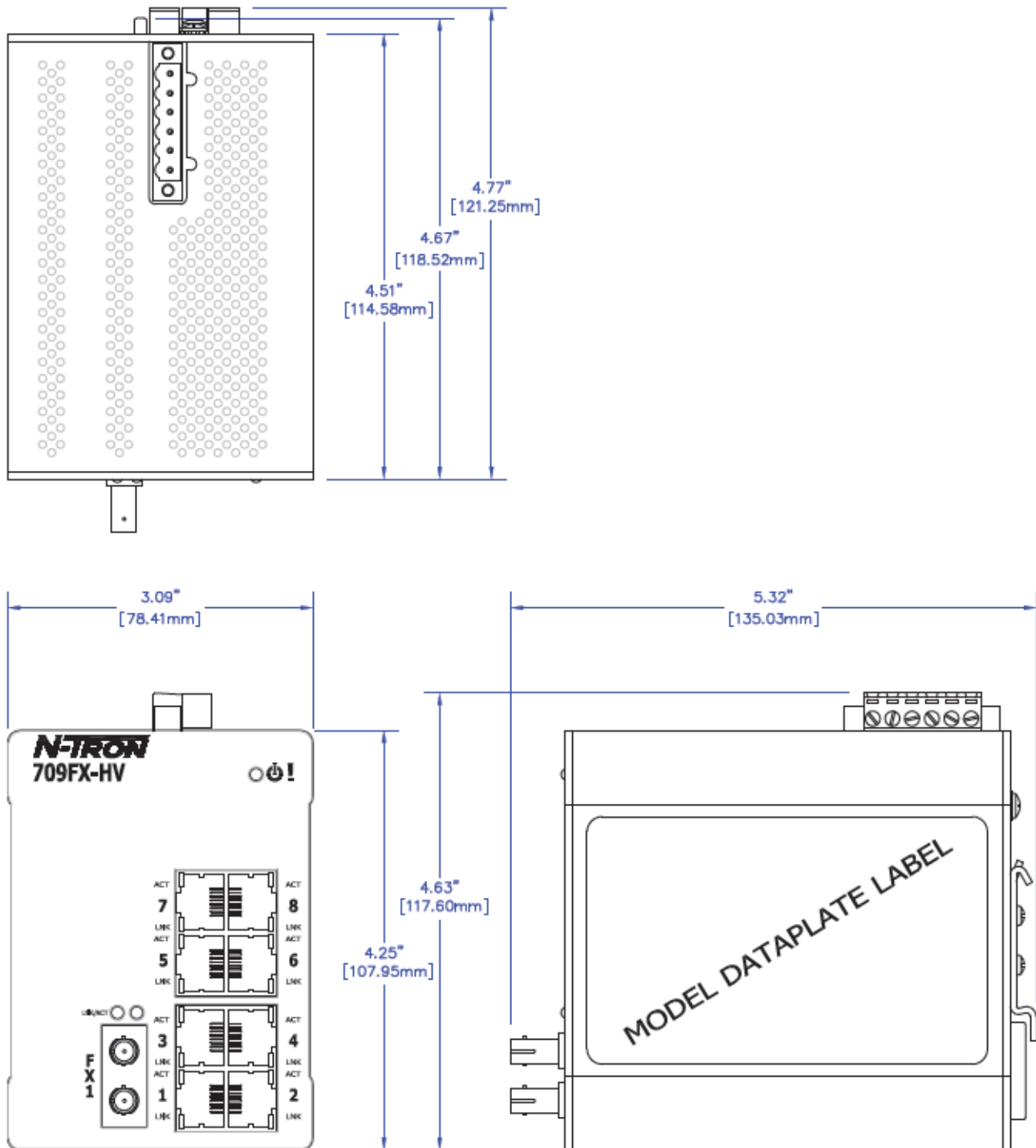

All specifications are subject to change. Consult the company website for more information.



## 1.4 710FX2

The versatile 710FX2 Industrial Ethernet switch is a fully managed switch that features eight 10/100 BaseTX RJ45 copper ports and two 100Base ST or SC fiber ports housed in a hardened metal DIN-Rail enclosure with redundant 10-49 VDC power inputs (HV 43-300 VDC available). Designed to handle the most demanding environments. The 710FX2 offers expanded shock and vibration ratings and wide -40 °C to 70 °C operating temperature rating. The 710FX2 combines outstanding performance and ease of use. The fully managed switch is ideally suited for connecting Ethernet-enabled industrial and/or security equipment.

### 1.4.1 Features and Benefits

#### Features and Benefits

Full IEEE 802.3 Compliance  
 Eight 10/100 Base-T(X) RJ45 Copper Ports  
 Two 100BaseFX(E) Ports  
 Redundant 10 to 49 VDC Power Inputs

- Keeps network running in the event of a power supply failure.
- HV High Voltage Option (43-300VDC)

-40 °C to 70 °C operating temperature  
 ESD and Surge Protection Diodes on all Ports  
 Autosensing 10/100BaseTX, Duplex, and MDIX  
 Offers Rapid Spanning Tree Protocol  
 Trunk with other N-Tron trunking capable switches over two ports  
 Store & Forward Technology  
 Plug-and-Play IGMP Support  
 Rugged DIN-Rail Enclosure  
 Onboard Temperature Sensor  
 Configuration Backup via optional SD Card (NTCD-128)  
 SNMP v1, v2 and v3  
 Web Browsing and N-View Switch Monitoring  
 Configurable Alarm Contact  
 Configurable Bi-Color Fault Status LED

#### Fully Managed Features Include:

- Full SNMP and Web Browser Management
- Detailed Ring Map and Fault Location Charting
- IGMP
- N-Ring™ Technology with ~30ms Healing
- N-View™ OPC Monitoring
- N-Link™ Redundant N-Ring Coupling
- 802.1Q VLAN Tagging and Port VLAN
- 802.1p QoS, Port QoS, and DSCP
- 802.1D RSTP (Rapid Spanning Tree Protocol)
- Ethernet/IP™ CIP Messaging
- LLDP (Link Layer Discovery Protocol)
- Trunking
- Port Mirroring
- DHCP Client, Server, Option 82 relay, Option 61, IP Fallback
- Local Port IP Addressing
- Port Security-MAC Address Based



\* HV Models Only



### 1.4.2 710FX2 Specifications

Mechanical				
Height	Width	Depth	Weight	Mount
4.3" (10.9 cm)	2.4" (6.1 cm) 3.1" (7.9 cm)*	4.6" (11.7 cm)	1.4 lbs (0.64 kg) 1.6 lbs (0.73 kg)*	35mm DIN-Rail
Power Input				
Input Voltage	Steady Input Current	BTU/hr		
10-49 VDC (Regulated)	415 mA @ 24 VDC	33.99 @ 24 VDC		
43-300 VDC (Regulated)*	95 mA @ 124 VDC*	41 @ 124 VDC*		
Environmental				
Operating Temperature	Storage Temperature	Operating Humidity		Operating Altitude
-40 °C to 70 °C	-40 °C to 85 °C	5% to 95% (non condensing)		0 to 10,000 ft.
Shock and Vibration				
Shock	Vibration		Note	
200g @ 10 ms	50g, 5-200Hz, Triaxial		Unit must be bulkhead mounted to achieve these levels.	
Connectors				
10/100BaseTX: Eight RJ45 copper ports 100BaseFX: Two SC or ST duplex fiber ports				
Recommended Minimum Wiring Clearance				
Top	1" (2.54 cm)			
Front	4" (10.16 cm)			
Bottom	1" (2.54 cm)			
Network Media				
10BaseT	100BaseTX	100BaseFX	100BaseFXE	
≥CAT3 Cable	≥CAT5 Cable	Multimode: 50-62.5/125µm	Singlemode: 7-10/125µm	
Switch Properties				
Number of MAC Addresses		Aging Time	Latency (Typical)	Switching Method
8,000		Programmable	2.6 µs	Store & Forward

Refer to ["100 MB Fiber Transceiver Characteristics"](#)

\* High voltage option



### 1.4.3 710FX2 Dimensions

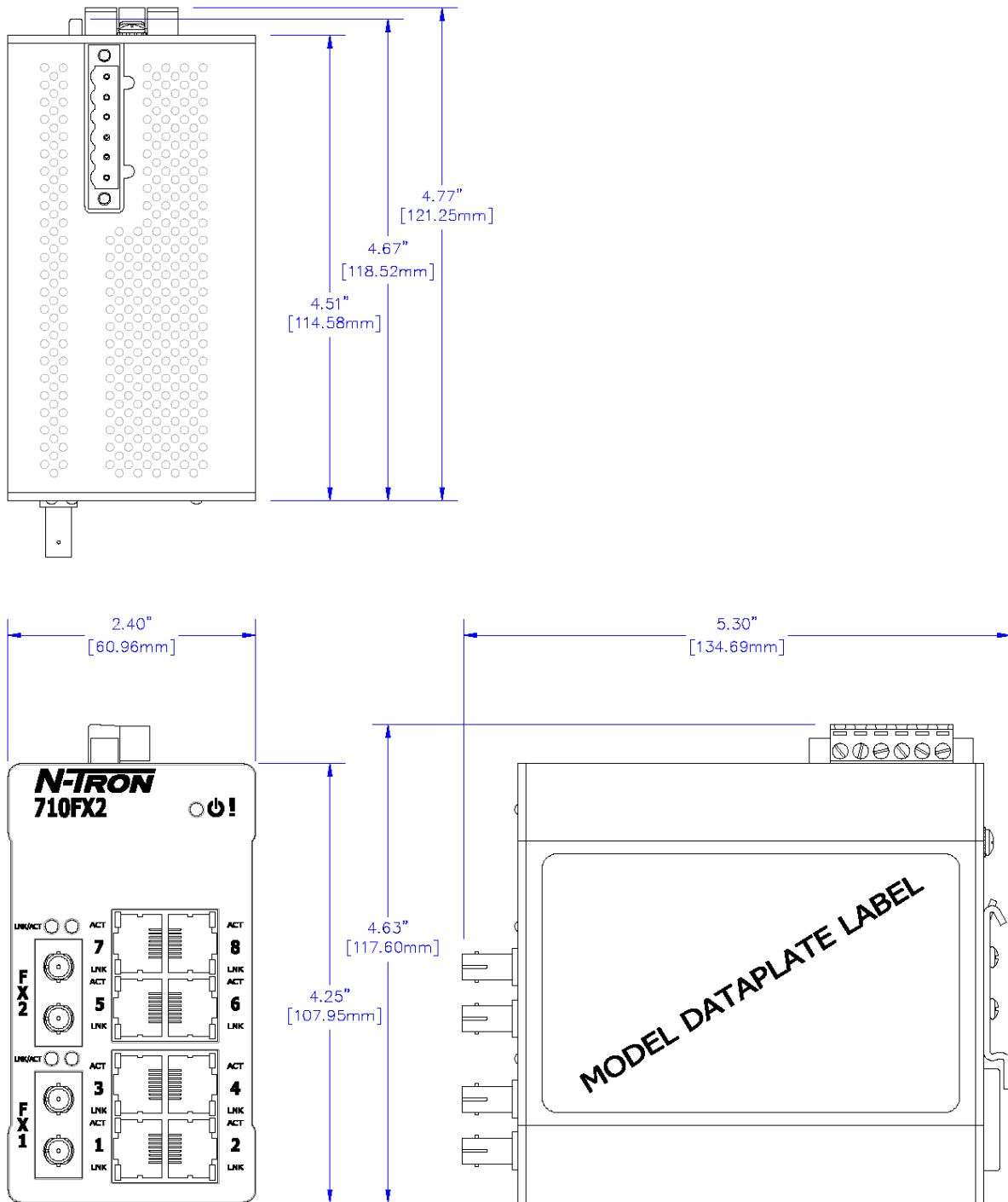

All specifications are subject to change. Consult the company website for more information.





### 1.4.4 710FX2-HV Dimensions

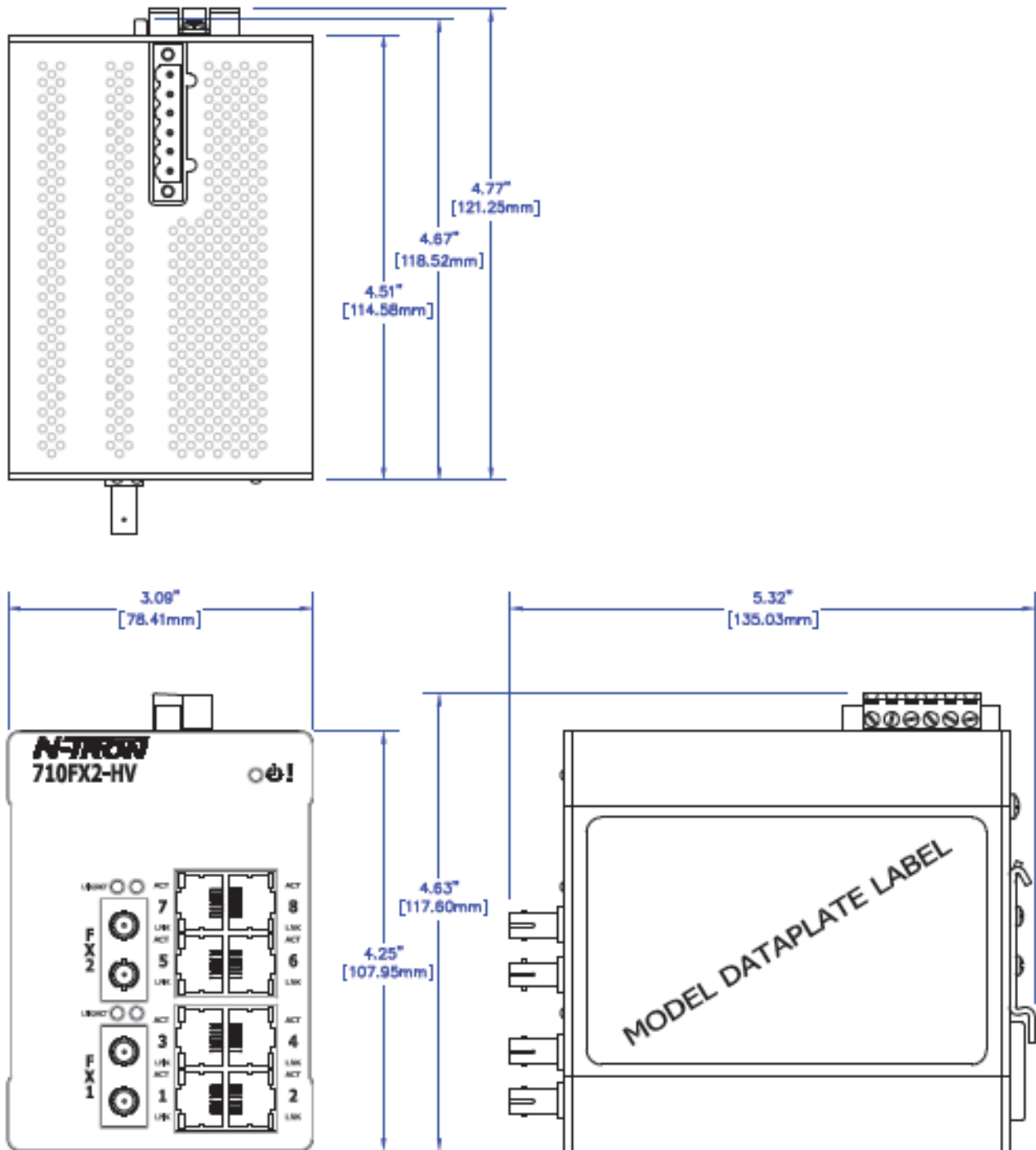

All specifications are subject to change. Consult the company website for more information.



## 1.5 711FX3

The versatile 711FX3 Industrial Ethernet switch is a fully managed switch that features eight 10/100 BaseTX RJ45 copper ports, three 100Base ST or SC fiber ports, and redundant 10-49 VDC power inputs (HV 43-300 VDC available). Designed to handle the most demanding environments it is ideally suited for use in industrial applications such as factory floor control networks, utilities, transportation applications and connecting Ethernet enabled industrial and or security equipment.

### 1.5.1 Features and Benefits

#### Features and Benefits

Full IEEE 802.3 Compliance  
 Eight 10/100 Base-T(X) RJ45 Copper Ports  
 Three 100BaseFX(E) Ports  
 Redundant 10 to 49 VDC Power Inputs
 

- Keeps network running in the event of a power supply failure.
- -HV High Voltage Option (43-300VDC)

 -40 °C to 70 °C operating temperature  
 ESD and Surge Protection Diodes on all Ports  
 Autosensing 10/100BaseTX, Duplex, and MDIX  
 Offers Rapid Spanning Tree Protocol  
 Trunk with other N-Tron trunking capable switches over two ports  
 Store & Forward Technology  
 Plug-and-Play IGMP Support  
 Rugged DIN-Rail Enclosure  
 Onboard Temperature Sensor  
 Configuration Backup via optional SD Card (NTCD-128)  
 SNMP v1, v2 and v3  
 Web Browsing and N-View Switch Monitoring  
 Configurable Alarm Contact  
 Configurable Bi-Color Fault Status LED

#### Fully Managed Features Include:

- Full SNMP and Web Browser Management
- Detailed Ring Map and Fault Location Charting
- IGMP
- N-Ring™ Technology with ~30ms Healing
- N-View™ OPC Monitoring
- N-Link™ Redundant N-Ring Coupling
- 802.1Q VLAN Tagging and Port VLAN
- 802.1p QoS, Port QoS, and DSCP
- 802.1D RSTP (Rapid Spanning Tree Protocol)
- Ethernet/IP™ CIP Messaging
- LLDP (Link Layer Discovery Protocol)
- Trunking
- Port Mirroring
- DHCP Client, Server, Option 82 relay, Option 61, IP Fallback
- Local Port IP Addressing
- Port Security-MAC Address Based



\* HV Models Only



## 1.5.2 711FX3 Specifications

Mechanical				
Height	Width	Depth	Weight	Mount
4.3" (10.9 cm)	2.4" (6.1 cm) 3.1" (7.9 cm)*	4.6" (11.7 cm)	1.4 lbs (0.64kg) 1.6 lbs (0.73kg)*	35mm DIN-Rail
Power Input				
Input Voltage	Steady Input Current	BTU/hr		
10-49 VDC (Regulated)	455 mA @ 24 VDC	37.27 @ 24 VDC		
43-300 VDC (Regulated)*	105 mA @ 124 VDC*	45 @ 124 VDC*		
Environmental				
Operating Temperature	Storage Temperature	Operating Humidity		Operating Altitude
-40 °C to 70 °C	-40 °C to 85 °C	5% to 95% (non condensing)		0 to 10,000 ft.
Shock and Vibration				
Shock	Vibration		Note	
200g @ 10 ms	50g, 5-200Hz, Triaxial		Unit must be bulkhead mounted to achieve these levels.	
Connectors				
10/100BaseTX: Eight RJ45 copper ports 100BaseFX: Three SC or ST duplex fiber ports				
Recommended Minimum Wiring Clearance				
Top	1" (2.54 cm)			
Front	4" (10.16 cm)			
Bottom	1" (2.54 cm)			
Network Media				
10BaseT	100BaseTX	100BaseFX	100BaseFXE	
≥CAT3 Cable	≥CAT5 Cable	Multimode: 50-62.5/125µm	Singlemode: 7-10/125µm	
Switch Properties				
Number of MAC Addresses		Aging Time	Latency (Typical)	Switching Method
8,000		Programmable	2.6 µs	Store & Forward

Refer to ["100 MB Fiber Transceiver Characteristics"](#)

\* High voltage option



### 1.5.3 711FX3 Dimensions

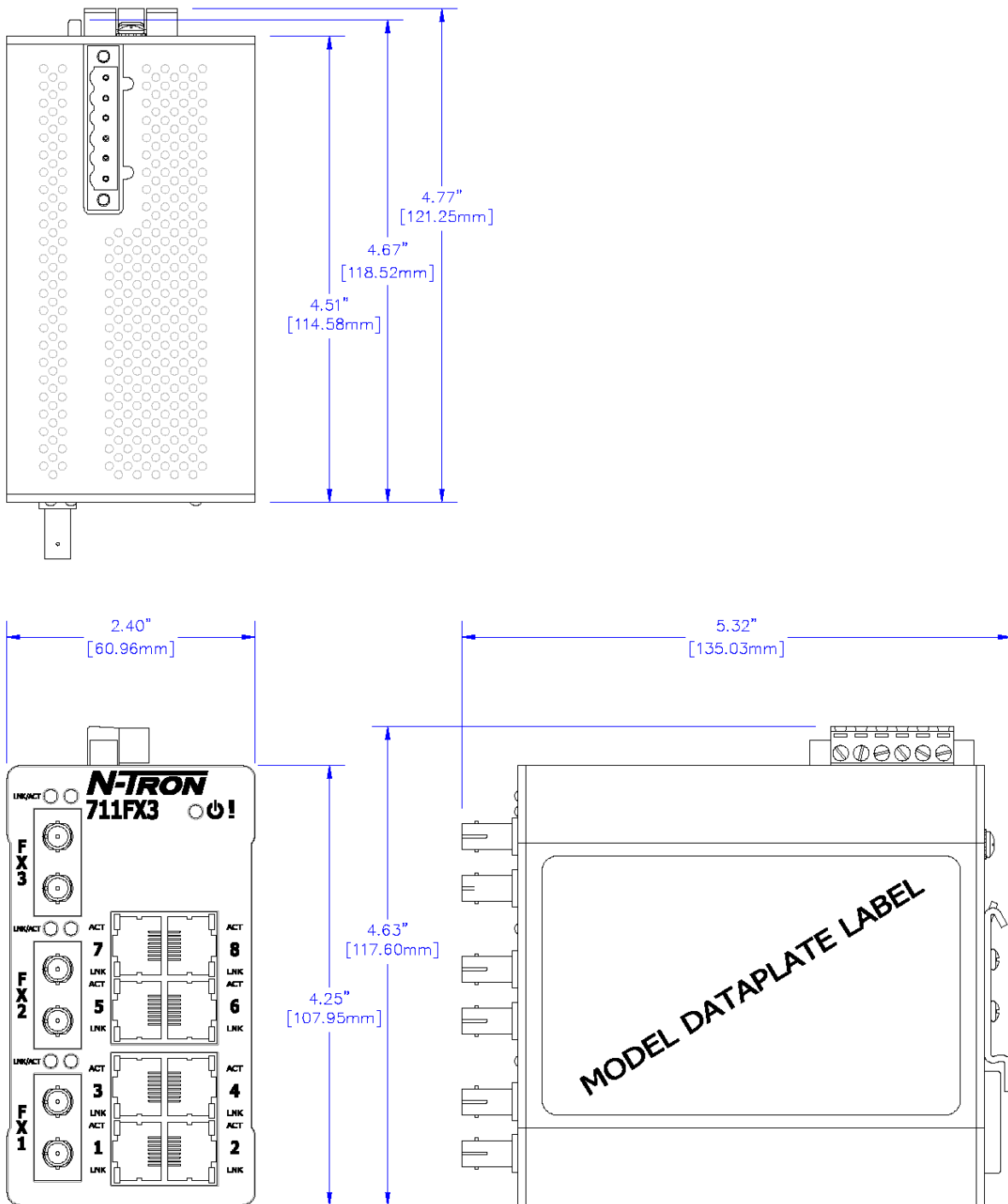

All specifications are subject to change. Consult the company website for more information.



### 1.5.4 711FX3-HV Dimensions

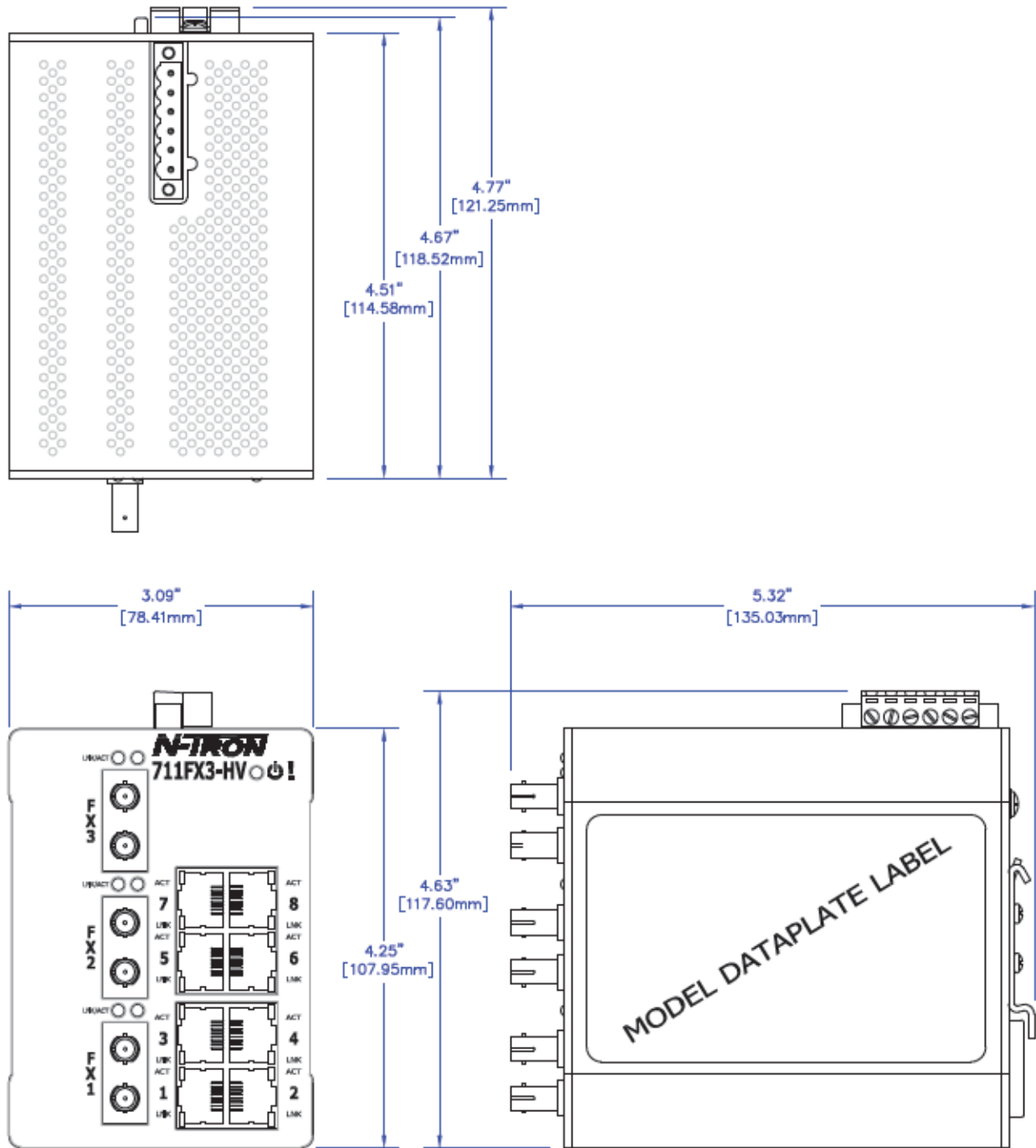

All specifications are subject to change. Consult the company website for more information.



## 1.6 712FX4

The versatile 712FX4 Industrial Ethernet switch is a fully managed switch that features eight 10/100 BaseTX RJ45 copper ports, four 100Base ST or SC fiber ports, and redundant 10-49 VDC power inputs (HV 43-300 VDC available). Designed to handle the most demanding environments it is ideally suited for use in industrial applications such as factory floor control networks, utilities, transportation applications and connecting Ethernet enabled industrial and or security equipment.

### 1.6.1 Features and Benefits

#### Features and Benefits

Full IEEE 802.3 Compliance  
 Eight 10/100 Base-T(X) RJ45 Copper Ports  
 Four 100BaseFX(E) Ports  
 Redundant 10 to 49 VDC Power Inputs
 

- Keeps network running in the event of a power supply failure.
- HV High Voltage Option (43-300VDC)

 -40 °C to 70 °C operating temperature  
 ESD and Surge Protection Diodes on all Ports  
 Autosensing 10/100BaseTX, Duplex, and MDIX  
 Offers Rapid Spanning Tree Protocol  
 Trunk with other N-Tron trunking capable switches over two ports  
 Store & Forward Technology  
 Plug-and-Play IGMP Support  
 Rugged DIN-Rail Enclosure  
 Onboard Temperature Sensor  
 Configuration Backup via optional SD Card (NTCD-128)  
 SNMP v1, v2 and v3  
 Web Browsing and N-View Switch Monitoring  
 Configurable Alarm Contact  
 Configurable Bi-Color Fault Status LED

#### Fully Managed Features Include:

- Full SNMP and Web Browser Management
- Detailed Ring Map and Fault Location Charting
- IGMP
- N-Ring™ Technology with ~30ms Healing
- N-View™ OPC Monitoring
- N-Link™ Redundant N-Ring Coupling
- 802.1Q VLAN Tagging and Port VLAN
- 802.1p QoS, Port QoS, and DSCP
- 802.1D RSTP (Rapid Spanning Tree Protocol)
- Ethernet/IP™ CIP Messaging
- LLDP (Link Layer Discovery Protocol)
- Trunking
- Port Mirroring
- DHCP Client, Server, Option 82 relay, Option 61, IP Fallback
- Local Port IP Addressing
- Port Security-MAC Address Based



\* HV Models Only



## 1.6.2 712FX4 Specifications

Mechanical				
Height	Width	Depth	Weight	Mount
4.3" (10.9 cm)	3.1" (7.9 cm)	4.6" (11.7 cm)	1.6 lbs (0.73kg) 1.75 lbs (0.79kg)*	35mm DIN-Rail
Power Input				
Input Voltage	Steady Input Current	BTU/hr		
10-49 VDC (Regulated)	505 mA @ 24 VDC	41.37 @ 24 VDC		
43-300 VDC (Regulated)*	115 mA @ 124 VDC*	49 @ 124 VDC*		
Environmental				
Operating Temperature	Storage Temperature	Operating Humidity		Operating Altitude
-40 °C to 70 °C	-40 °C to 85 °C	5% to 95% (non condensing)		0 to 10,000 ft.
Shock and Vibration				
Shock	Vibration		Note	
200g @ 10 ms	50g, 5-200Hz, Triaxial		Unit must be bulkhead mounted to achieve these levels.	
Connectors				
10/100BaseTX: Eight RJ45 copper ports 100BaseFX: Four SC or ST duplex fiber ports				
Recommended Minimum Wiring Clearance				
Top	1" (2.54 cm)			
Front	4" (10.16 cm)			
Bottom	1" (2.54 cm)			
Network Media				
10BaseT	100BaseTX	100BaseFX	100BaseFXE	
≥CAT3 Cable	≥CAT5 Cable	Multimode: 50-62.5/125µm	Singlemode: 7-10/125µm	
Switch Properties				
Number of MAC Addresses		Aging Time	Latency (Typical)	Switching Method
8,000		Programmable	2.6 µs	Store & Forward

Refer to ["100 MB Fiber Transceiver Characteristics"](#)

\* High voltage option



### 1.6.3 712FX4 Dimensions

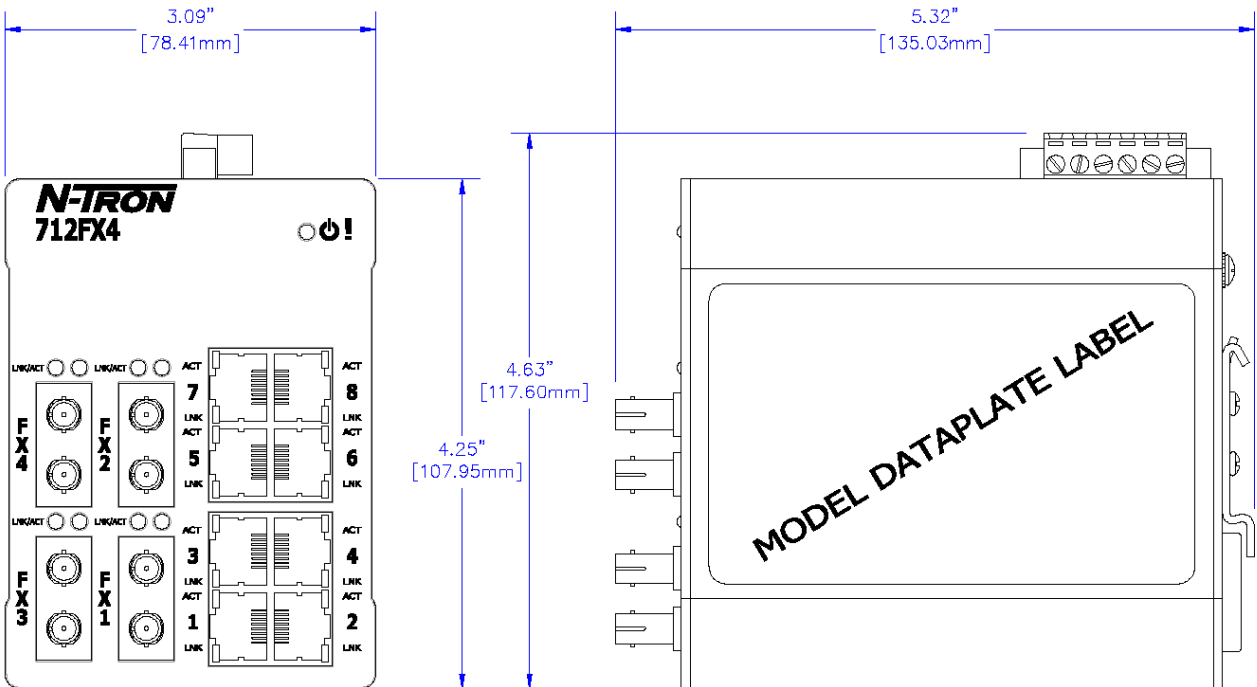
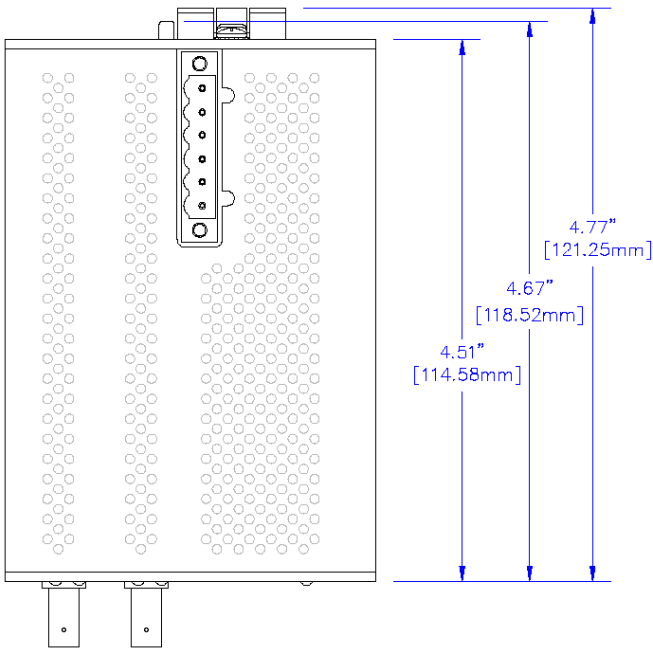

All specifications are subject to change. Consult the company website for more information.





### 1.6.4 712FX4-HV Dimensions

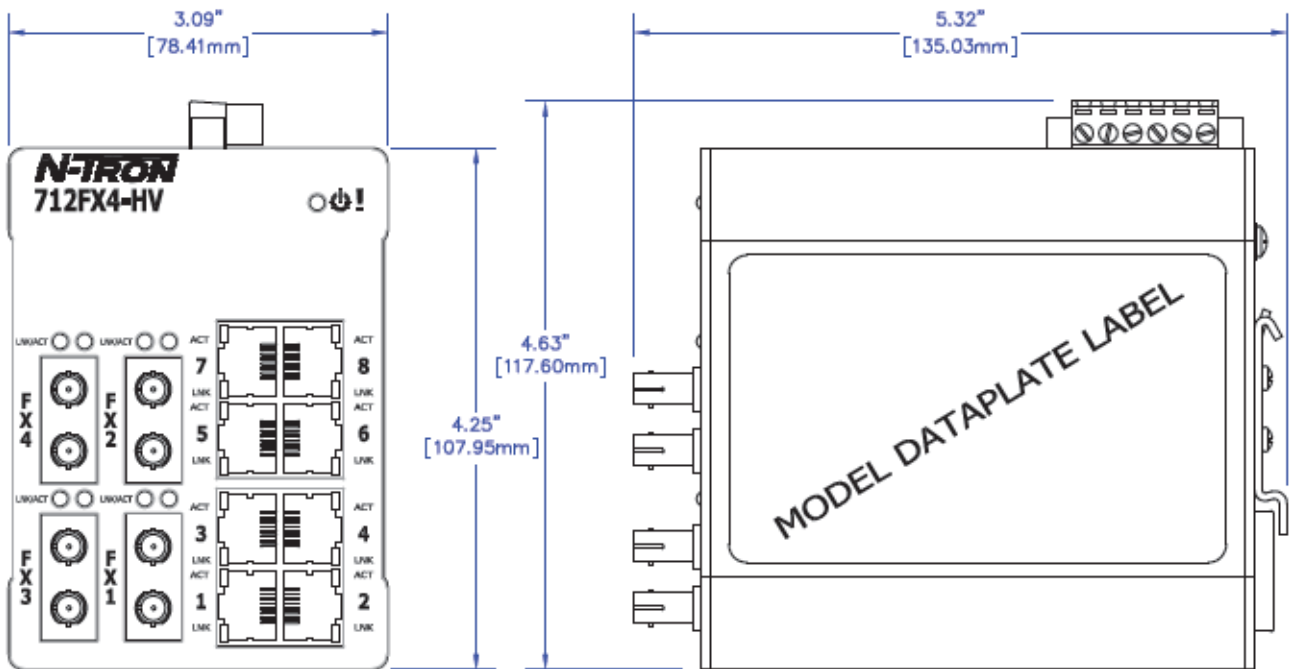
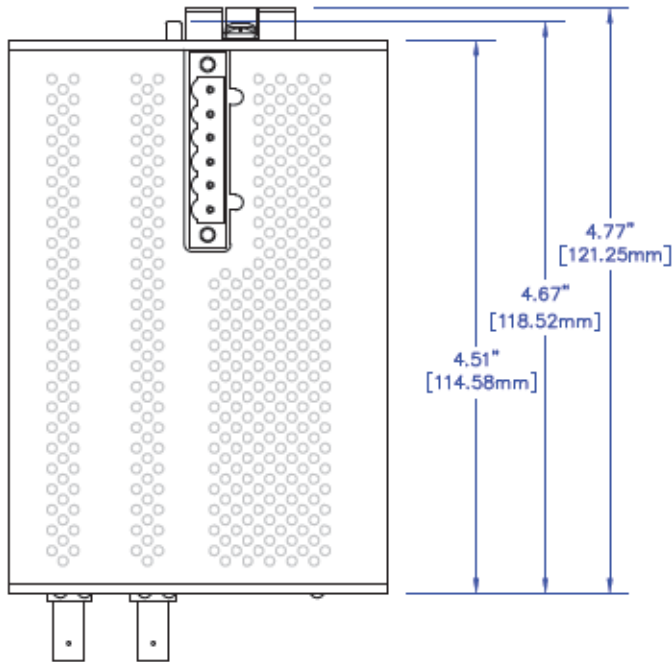

All specifications are subject to change. Consult the company website for more information.



## 1.7 714FX6

The versatile 714FX6 Industrial Ethernet switch is a fully managed switch that features eight 10/100 BaseTX RJ45 copper ports, six 100Base ST or SC fiber ports, and redundant 10-49 VDC power inputs. Designed to handle the most demanding environments it is ideally suited for use in industrial applications such as factory floor control networks, utilities, transportation applications and connecting Ethernet enabled industrial and or security equipment.

### 1.7.1 Features and Benefits

#### Features and Benefits

Full IEEE 802.3 Compliance  
 Eight 10/100 Base-T(X) RJ45 Copper Ports  
 Six 100BaseFX(E) Ports  
 Redundant 10 to 49 VDC Power Inputs
 

- Keeps network running in the event of a power supply failure.

 -40 °C to 70 °C operating temperature  
 ESD and Surge Protection Diodes on all Ports  
 Autosensing 10/100BaseTX, Duplex, and MDIX  
 Offers Rapid Spanning Tree Protocol  
 Trunk with other N-Tron trunking capable switches over two ports  
 Store & Forward Technology  
 Plug-and-Play IGMP Support  
 Rugged DIN-Rail Enclosure  
 Onboard Temperature Sensor  
 Configuration Backup via optional SD Card (NTCD-128)  
 SNMP v1, v2 and v3  
 Web Browsing and N-View Switch Monitoring  
 Configurable Alarm Contact  
 Configurable Bi-Color Fault Status LED

#### Fully Managed Features Include:

- Full SNMP and Web Browser Management
- Detailed Ring Map and Fault Location Charting
- IGMP
- N-Ring™ Technology with ~30ms Healing
- N-View™ OPC Monitoring
- N-Link™ Redundant N-Ring Coupling
- 802.1Q VLAN Tagging and Port VLAN
- 802.1p QoS, Port QoS, and DSCP
- 802.1D RSTP (Rapid Spanning Tree Protocol)
- Ethernet/IP™ CIP Messaging
- LLDP (Link Layer Discovery Protocol)
- Trunking
- Port Mirroring
- DHCP Client, Server, Option 82 relay, Option 61, IP Fallback
- Local Port IP Addressing
- Port Security-MAC Address Based



### 1.7.2 714FX6 Specifications

Mechanical				
Height	Width	Depth	Weight	Mount
4.3" (10.9 cm)	3.1" (7.9 cm)	4.6" (11.7 cm)	1.8 lbs (0.8 kg)	35mm DIN-Rail
Power Input				
Input Voltage	Steady Input Current	Input Current	BTU/hr	
10-49 VDC (Regulated)	610 mA @ 24 VDC	Less than 100 mV	49.96 @ 24 VDC	
Environmental				
Operating Temperature	Storage Temperature	Operating Humidity		Operating Altitude
-40 °C to 70 °C	-40 °C to 85 °C	5% to 95% (non condensing)		0 to 10,000 ft.
Shock and Vibration				
Shock	Vibration		Note	
200g @ 10 ms	50g, 5-200Hz, Triaxial		Unit must be bulkhead mounted to achieve these levels.	
Connectors				
10/100BaseTX: Eight RJ45 copper ports 100BaseFX: Six SC or ST duplex fiber ports				
Recommended Minimum Wiring Clearance				
Top	1" (2.54 cm)			
Front	4" (10.16 cm)			
Bottom	1" (2.54 cm)			
Network Media				
10BaseT	100BaseTX	100BaseFX	100BaseFXE	
≥CAT3 Cable	≥CAT5 Cable	Multimode: 50-62.5/125µm	Singlemode: 7-10/125µm	
Switch Properties				
Number of MAC Addresses		Aging Time	Latency (Typical)	Switching Method
8,000		Programmable	2.6 µs	Store & Forward

Refer to "100 MB Fiber Transceiver Characteristics"



### 1.7.3 714FX6 Dimensions

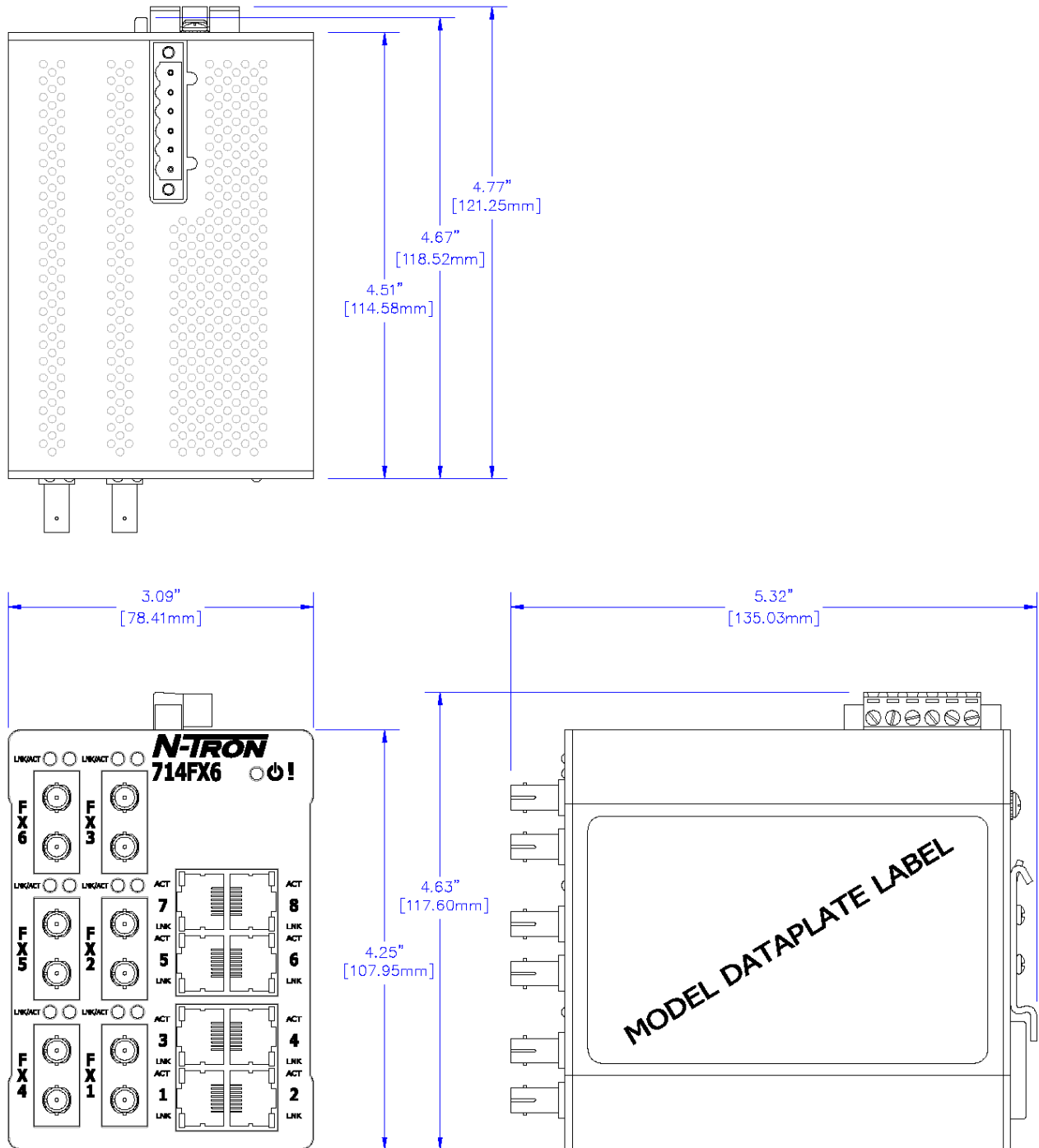

All specifications are subject to change. Consult the company website for more information.



## 1.8 7010TX

The versatile 7010TX Industrial Ethernet switch is a fully managed switch that features eight 10/100 BaseTX RJ45 copper ports, two SFP gigabit ports, and redundant 10-49 VDC power inputs. Designed to handle the most demanding environments it is ideally suited for use in industrial applications such as factory floor control networks, utilities, transportation applications and any other application where high reliability, superior noise immunity, extreme ruggedness, and extended distance are required.

### 1.8.1 Features and Benefits

#### Features and Benefits

Full IEEE 802.3 Compliance  
Eight 10/100 Base-T(X) RJ45 Copper Ports  
Two Optional SFP (Mini-GBIC) Gigabit Transceivers

- 1000BaseSX/LX Ports, LC style
- 1000BaseT Ports, RJ45 style

Redundant 10 to 49 VDC Power Inputs

- Keeps network running in the event of a power supply failure.

-40 °C to 70 °C operating temperature  
ESD and Surge Protection Diodes on all Ports  
Autosensing 10/100BaseTX, Duplex, and MDIX  
Offers Rapid Spanning Tree Protocol  
Trunk with other N-Tron trunking capable switches over two ports  
Store & Forward Technology  
Plug-and-Play IGMP Support  
Rugged DIN-Rail Enclosure  
Onboard Temperature Sensor  
Configuration Backup via optional SD Card (NTCD-128)  
SNMP v1, v2 and v3  
Web Browsing and N-View Switch Monitoring  
Configurable Alarm Contact  
Configurable Bi-Color Fault Status LED

#### Fully Managed Features Include:

- Full SNMP and Web Browser Management
- Detailed Ring Map and Fault Location Charting
- IGMP
- N-Ring™ Technology with ~30ms Healing
- N-View™ OPC Monitoring
- N-Link™ Redundant N-Ring Coupling
- 802.1Q VLAN Tagging and Port VLAN
- 802.1p QoS, Port QoS, and DSCP
- 802.1D RSTP (Rapid Spanning Tree Protocol)
- Ethernet/IP™ CIP Messaging
- LLDP (Link Layer Discovery Protocol)
- Trunking
- Port Mirroring
- DHCP Client, Server, Option 82 relay, Option 61, IP Fallback
- Local Port IP Addressing
- Port Security-MAC Address Based



### 1.8.2 7010TX Specifications

Mechanical				
Height	Width	Depth	Weight	Mount
4.3" (10.9 cm)	2.4" (6.1 cm)	4.6" (11.7 cm)	1.38 lbs (0.63 kg)	35mm DIN-Rail
Power Input				
Input Voltage	Steady Input Current	BTU/hr		
10-49 VDC (Regulated)	410 mA @ 24 VDC	33.6 @ 24 VDC		
Environmental				
Operating Temperature	Storage Temperature	Operating Humidity		Operating Altitude
-40 °C to 70 °C	-40 °C to 85 °C	5% to 95% (non condensing)		0 to 10,000 ft.
Shock and Vibration				
Shock	Vibration		Note	
200g @ 10 ms	50g, 5-200Hz, Triaxial		Unit must be bulkhead mounted to achieve these levels.	
Connectors				
10/100BaseTX: Eight RJ45 copper ports Optional SFP Ports: 1000BaseT: Up to two RJ45 gigabit copper ports or, 1000BaseSX/LX: Up to two LC duplex gigabit fiber ports				
Recommended Minimum Wiring Clearance				
Top	1" (2.54 cm)			
Front	4" (10.16 cm)			
Bottom	1" (2.54 cm)			
Network Media				
10BaseT	100BaseTX	1000BaseT	1000BaseSX	1000BaseLX
≥CAT3 Cable	≥CAT5 Cable	≥CAT5E Cable	Multimode: 50-62.5/125µm	Singlemode: 7-10/125µm
Switch Properties				
Number of MAC Addresses		Aging Time	Latency (Typical)	Switching Method
8,000		Programmable	2.6 µs	Store & Forward

Refer to ["Gigabit Fiber Transceiver \(SFP\) Characteristics"](#)



### 1.8.3 7010TX Dimensions

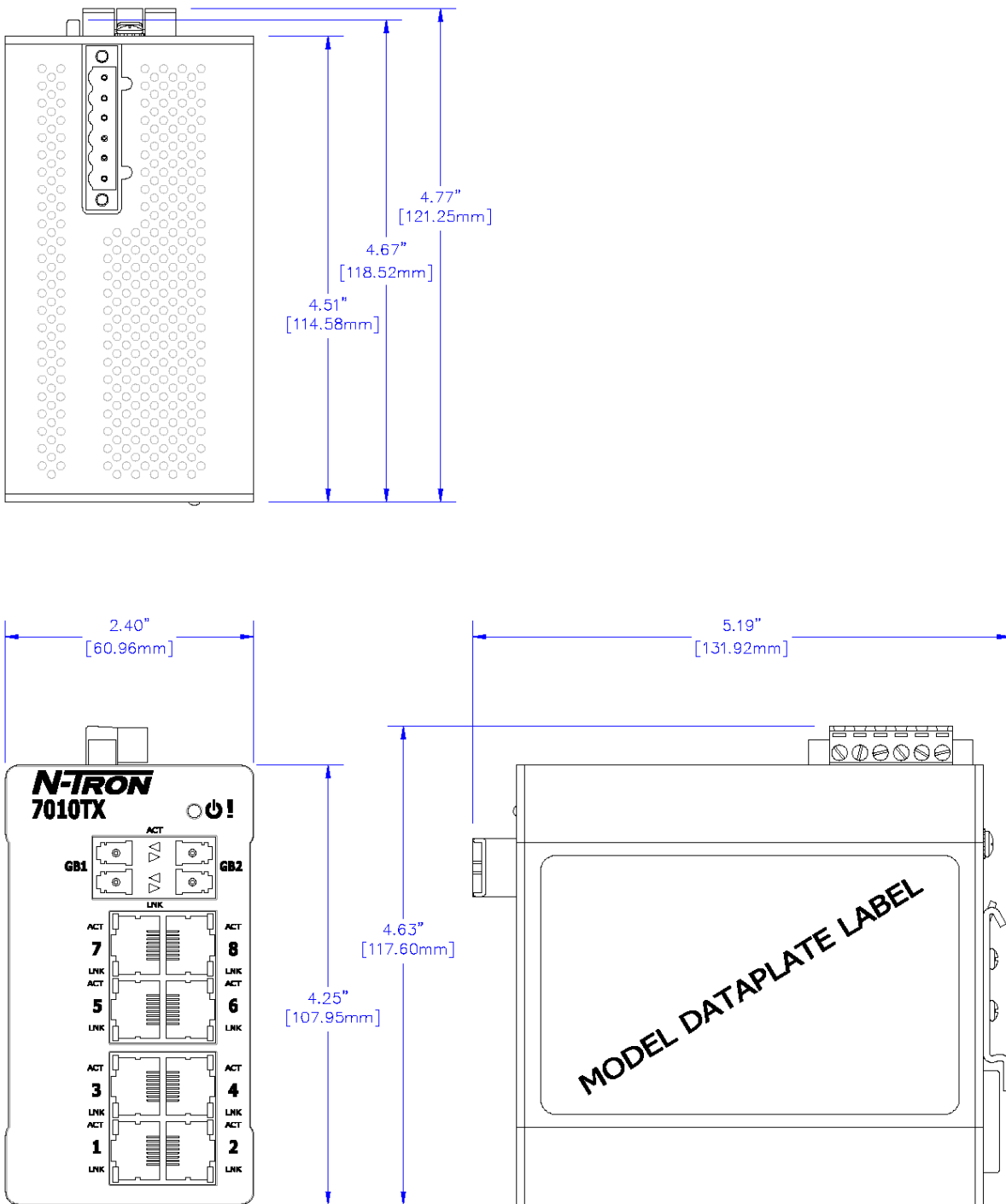

All specifications are subject to change. Consult the company website for more information.



## 1.9 7012FX2

The versatile 7012FX2 Industrial Ethernet switch is a fully managed switch that features eight 10/100 BaseTX RJ45 copper ports, two 100Base ST or SC fiber ports, two SFP gigabit ports, and redundant 10-49 VDC power inputs (HV 43-300 VDC available). Designed to handle the most demanding environments it is ideally suited for use in industrial applications such as factory floor control networks, utilities, wastewater treatment, wind turbines, rail car, intelligent traffic control and transportation.

### 1.9.1 Features and Benefits

#### Features and Benefits

Full IEEE 802.3 Compliance  
 Eight 10/100 Base-T(X) RJ45 Copper Ports  
 Two 100BaseFX(E) Ports  
 Two Optional SFP (Mini-GBIC Gigabit Transceivers)
 

- 1000BaseSX/LX Ports, LC style
- 1000BaseT Ports, RJ45 style

 Redundant 10 to 49 VDC Power Inputs
 

- Keeps network running in the event of a power supply failure.
- -HV High Voltage Option (43-300VDC)

 -40 °C to 70 °C operating temperature  
 ESD and Surge Protection Diodes on all Ports  
 Autosensing 10/100BaseTX, Duplex, and MDIX  
 Offers Rapid Spanning Tree Protocol  
 Trunk with other N-Tron trunking capable switches over two ports  
 Store & Forward Technology  
 Plug-and-Play IGMP Support  
 Rugged DIN-Rail Enclosure  
 Onboard Temperature Sensor  
 Configuration Backup via optional SD Card (NTCD-128)  
 SNMP v1, v2 and v3  
 Web Browsing and N-View Switch Monitoring  
 Configurable Alarm Contact  
 Configurable Bi-Color Fault Status LED

#### Fully Managed Features Include:

- Full SNMP and Web Browser Management
- Detailed Ring Map and Fault Location Charting
- IGMP
- N-Ring™ Technology with ~30ms Healing
- N-View™ OPC Monitoring
- N-Link™ Redundant N-Ring Coupling
- 802.1Q VLAN Tagging and Port VLAN
- 802.1p QoS, Port QoS, and DSCP
- 802.1D RSTP (Rapid Spanning Tree Protocol)
- Ethernet/IP™ CIP Messaging
- LLDP (Link Layer Discovery Protocol)
- Trunking
- Port Mirroring
- DHCP Client, Server, Option 82 relay, Option 61, IP Fallback
- Local Port IP Addressing
- Port Security-MAC Address Based



\* HV Models Only





### 1.9.2 7012FX2 Specifications

Mechanical				
Height	Width	Depth	Weight	Mount
4.3" (10.9 cm)	3.1" (7.9 cm)	4.6" (11.7 cm)	1.65 lbs (0.75 kg)	35mm DIN-Rail
Power Input				
Input Voltage	Steady Input Current	BTU/hr		
10-49 VDC (Regulated)	525 mA @ 24 VDC	44 @ 24 VDC		
43-300 VDC (Regulated)*	140 mA @ 124 VDC*	60 @ 124 VDC*		
Environmental				
Operating Temperature	Storage Temperature	Operating Humidity		Operating Altitude
-40 °C to 70 °C	-40 °C to 85 °C	5% to 95% (non condensing)		0 to 10,000 ft.
Shock and Vibration				
Shock	Vibration		Note	
200g @ 10 ms	50g, 5-200Hz, Triaxial		Unit must be bulkhead mounted to achieve these levels.	
Connectors				
10/100BaseTX: Eight RJ45 copper ports 100BaseFX: Two SC or ST duplex fiber ports Optional SFP Ports: 1000BaseT: Up to two RJ45 gigabit copper ports or, 1000BaseSX/LX: Up to two LC duplex gigabit fiber ports				
Recommended Minimum Wiring Clearance				
Top	1" (2.54 cm)			
Front	4" (10.16 cm)			
Bottom	1" (2.54 cm)			
Network Media				
10BaseT	100BaseTX	1000BaseT	100BaseFX, 1000BaseSX	100BaseFXE, 1000BaseLX
≥CAT3 Cable	≥CAT5 Cable	≥CAT5E Cable	Multimode: 50-62.5/125µm	Singlemode: 7-10/125µm
Switch Properties				
Number of MAC Addresses		Aging Time	Latency (Typical)	Switching Method
8,000		Programmable	2.6 µs	Store & Forward

Refer to ["100 MB Fiber Transceiver Characteristics"](#)

Refer to ["Gigabit Fiber Transceiver \(SFP\) Characteristics"](#)

\* High voltage option



### 1.9.3 7012FX2 Dimensions

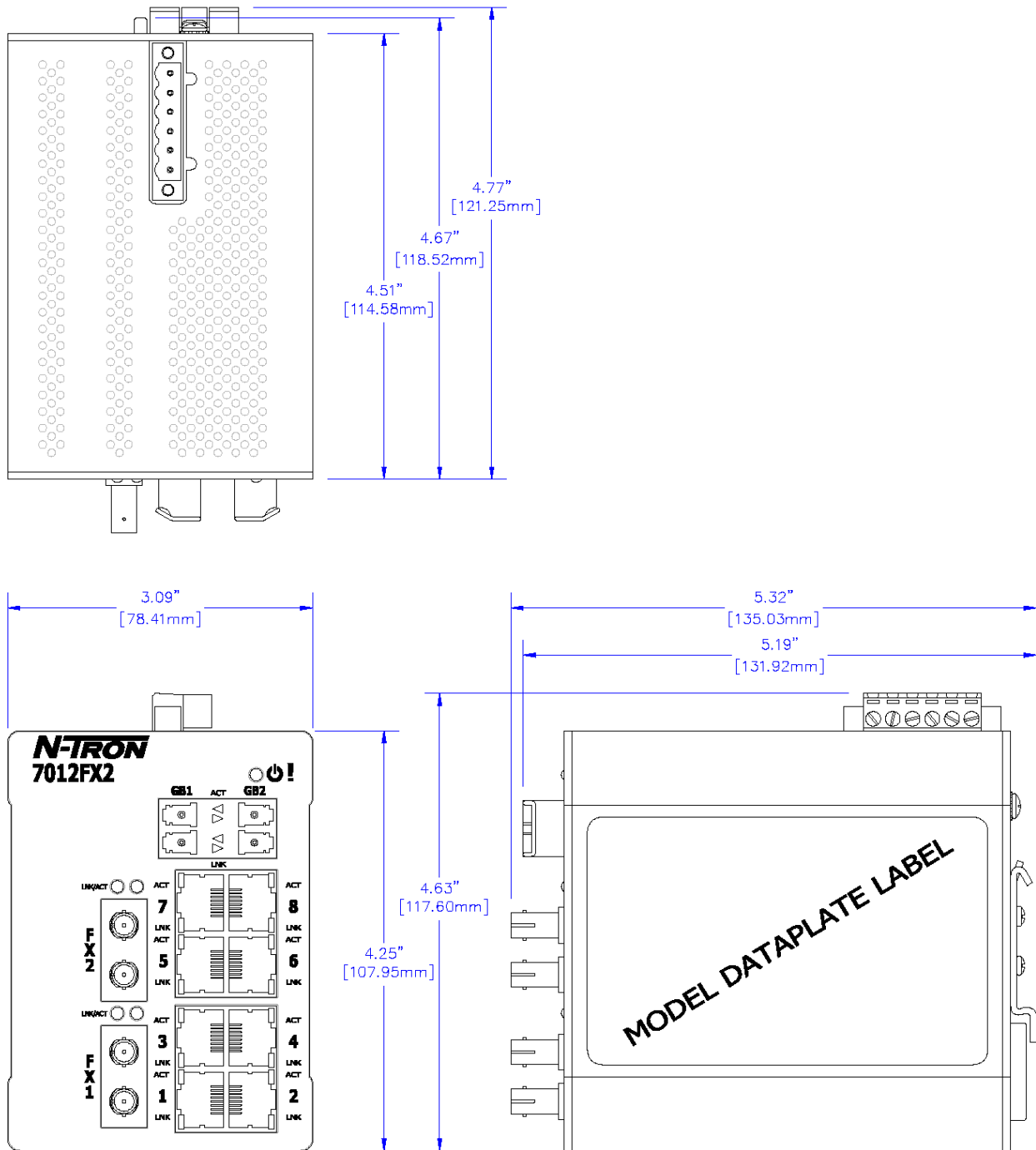

All specifications are subject to change. Consult the company website for more information.



## 1.10 7026TX

The 7026TX Industrial Ethernet managed switch features 24 10/100 Base-TX RJ45 copper ports, up to two optional 1000Base SFP (Mini-GBIC) full duplex ports housed in a hardened 1U rackmount enclosure with redundant 18-49 VDC power inputs (optional AC voltage available). The 7026TX offers outstanding performance in high traffic industrial environments with a wide -40 °C to 80 °C operating temperature rating (includes onboard sensor). The two optional SFP ports are available for either 1000BaseSX/LX fiber transceiver with LC connectors or, 1000BaseT copper transceiver with RJ45 connectors.

### 1.10.1 Features and Benefits

Full IEEE 802.3 Compliance

Twenty four 10/100 Base-T(X) RJ45 Copper Ports

Two Optional SFP (Mini-GBIC) Gigabit Transceivers

- 1000BaseSX/LX Ports, LC style
- 1000BaseT Ports, RJ45 style

Redundant 18 to 49 VDC Power Inputs

- Keeps network running in the event of a power supply failure.
- High Voltage Option (90-264 VAC) or (90-300VDC)

-40 °C to 80 °C operating temperature

ESD and Surge Protection Diodes on all Ports

Autosensing 10/100BaseTX, Duplex, and MDIX

Offers Rapid Spanning Tree Protocol

Trunk with other N-Tron trunking capable switches over two ports

Store & Forward Technology

Plug-and-Play IGMP Support

Rugged Rack Mount Enclosure

Onboard Temperature Sensor

Configuration Backup via optional SD Card (NTCD-128)

SNMP v1, v2 and v3

Web Browsing and N-View Switch Monitoring

Configurable Alarm Contact

Configurable Bi-Color Fault Status LED

Fully Managed Features Include:

- Full SNMP and Web Browser Management
- Detailed Ring Map and Fault Location Charting
- IGMP
- N-Ring™ Technology with ~30ms Healing
- N-View™ OPC Monitoring
- N-Link™ Redundant N-Ring Coupling
- 802.1Q VLAN Tagging and Port VLAN
- 802.1p QoS, Port QoS, and DSCP
- 802.1D RSTP (Rapid Spanning Tree Protocol)
- Ethernet/IP™ CIP Messaging
- LLDP (Link Layer Discovery Protocol)
- Trunking
- Port Mirroring
- DHCP Client, Server, Option 82 relay, Option 61, IP Fallback
- Local Port IP Addressing
- Port Security-MAC Address Based



### 1.10.2 7026TX Specifications

Mechanical				
Height	Width	Depth	Weight	Mount
1.75" (4.45 cm)	19.0" (48.26 cm)	5.4" (13.7 cm)	5.5 lbs (2.5 kg)	Rack/Panel
Power Input				
Input Voltage	Steady Input Current	BTU/hr		
18-49 VDC (Regulated)	605 mA @ 24 VDC	49.6 @ 24 VDC		
90-264 VAC*	215 mA @ 120 VAC*	100 @ 120 VAC*		
90-300 VDC*	110 mA @ 124 VDC*	47 @ 124 VDC*		
Environmental				
Operating Temperature	Storage Temperature	Operating Humidity		Operating Altitude
-40 °C to 80 °C	-40 °C to 85 °C	5% to 95% (non condensing)		0 to 10,000 ft.
Shock and Vibration				
Shock	Vibration		Note	
200g @ 10 ms	50g, 5-200Hz, Triaxial		Unit must be bulkhead mounted to achieve these levels.	
Connectors				
10/100BaseTX: 24 RJ45 copper ports Optional SFP Ports: 1000BaseT: Up to two RJ45 gigabit copper ports or, 1000BaseSX/LX: Up to two LC duplex gigabit fiber ports				
Recommended Minimum Wiring Clearance				
Top	1" (2.54 cm)			
Front	4" (10.16 cm)			
Back	1" (2.54 cm) (7026TX) 2" (5.08 cm) (7026TX-AC)			
Bottom	1" (2.54 cm)			
Network Media				
10BaseT	100BaseTX	1000BaseT	1000BaseSX	1000BaseLX
≥CAT3 Cable	≥CAT5 Cable	≥CAT5E Cable	Multimode: 50-62.5/125µm	Singlemode: 7-10/125µm
Switch Properties				
Number of MAC Addresses		Ageing Time	Latency (Typical)	Switching Method
8,000		Programmable	2.6 µs	Store & Forward

Refer to ["Gigabit Fiber Transceiver \(SFP\) Characteristics"](#)

\* 7026TX-AC model



### 1.10.3 7026TX Dimensions

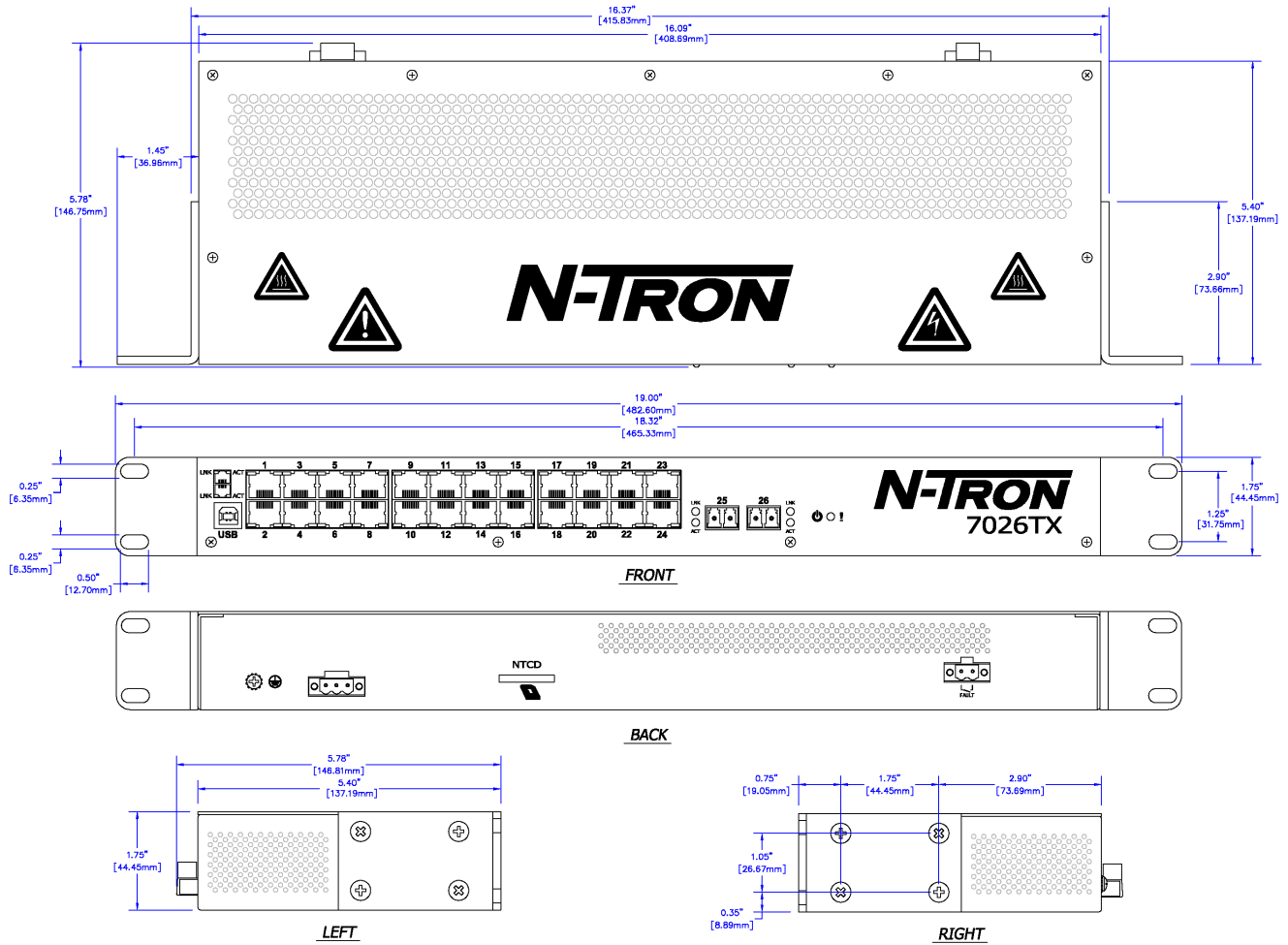

All specifications are subject to change. Consult the company website for more information.



## 1.11 7506GX2

The 7506GX2 Industrial Ethernet switch is a fully managed switch that features four 10/100/1000BaseT (X) RJ45 copper ports, two SFP (Mini-GBIC) gigabit ports, and redundant 10-49 VDC power inputs. Designed to handle the most demanding environments it offers expanded shock and vibration ratings and wide -40 °C to 80 °C operating temperature rating. It is ideally suited for connecting Ethernet enabled industrial and security equipment.

### 1.11.1 Features and Benefits

#### Features and Benefits

Full IEEE 802.3 Compliance  
Four 10/100/1000 Base-T(X) RJ45 Copper Ports  
Two Optional SFP (Mini-GBIC) Gigabit Transceivers

- 1000BaseSX/LX Ports, LC style
- 1000BaseT Ports, RJ45 style

Redundant 10 to 49 VDC Power Inputs

- Keeps network running in the event of a power supply failure.

-40 °C to 80 °C operating temperature  
ESD and Surge Protection Diodes on all Ports  
Autosensing 10/100/1000BaseTX, Duplex, and MDIX  
Offers Rapid Spanning Tree Protocol  
Trunk with other N-Tron trunking capable switches over two ports  
Store & Forward Technology  
Plug-and-Play IGMP Support  
Rugged DIN-Rail Enclosure  
Onboard Temperature Sensor  
Configuration Backup via optional SD Card (NTCD-128)  
SNMP v1, v2 and v3  
Web Browsing and N-View Switch Monitoring  
Configurable Bi-Color Fault Status LED

#### Fully Managed Features Include:

- Full SNMP and Web Browser Management
- Detailed Ring Map and Fault Location Charting
- IGMP
- N-Ring™ Technology with ~30ms Healing
- N-View™ OPC Monitoring
- N-Link™ Redundant N-Ring Coupling
- 802.1Q VLAN Tagging and Port VLAN
- 802.1p QoS, Port QoS, and DSCP
- 802.1D RSTP (Rapid Spanning Tree Protocol)
- Ethernet/IP™ CIP Messaging
- LLDP (Link Layer Discovery Protocol)
- Trunking
- Port Mirroring
- DHCP Client, Server, Option 82 relay, Option 61, IP Fallback
- Local Port IP Addressing
- Port Security-MAC Address Based



### 1.11.2 7506GX2 Specifications

Mechanical				
Height	Width	Depth	Weight	Mount
3.75" (9.53 cm)	2.00" (5.08 cm)	3.87" (9.83 cm)	1.05 lbs (0.48 kg)	35mm DIN-Rail
Power Input				
Input Voltage	Steady Input Current	BTU/hr		
10-49 VDC (Regulated)	440 mA @ 24 VDC	36 @ 24 VDC		
Environmental				
Operating Temperature	Storage Temperature	Operating Humidity		Operating Altitude
-40°C to 80°C	-40°C to 85°C	5% to 95% (non condensing)		0 to 10,000 ft.
Shock and Vibration				
Shock	Vibration		Note	
200g @ 10ms	50g, 5-200Hz, Triaxial		Unit must be bulkhead mounted to achieve these levels.	
Connectors				
10/100/1000BaseT(X): Four RJ45 copper ports Optional SFP Ports: 1000BaseT: Up to two RJ45 gigabit copper ports or, 1000BaseSX/LX: Up to two LC duplex gigabit fiber ports				
Recommended Minimum Wiring Clearance				
Side	1" (2.54 cm)			
Front	4" (10.16 cm)			
Network Media				
10BaseT	100BaseTX	1000BaseT	1000BaseSX	1000BaseLX
≥CAT3 Cable	≥CAT5 Cable	≥CAT5E Cable	Multimode: 50-62.5/125µm	Singlemode: 7-10/125µm
Switch Properties				
Number of MAC Addresses		Aging Time	Latency (Typical)	Switching Method
4,000		Programmable	1.6 µs	Store & Forward

Refer to ["Gigabit Fiber Transceiver \(SFP\) Characteristics"](#)



### 1.11.3 7506GX2 Dimensions

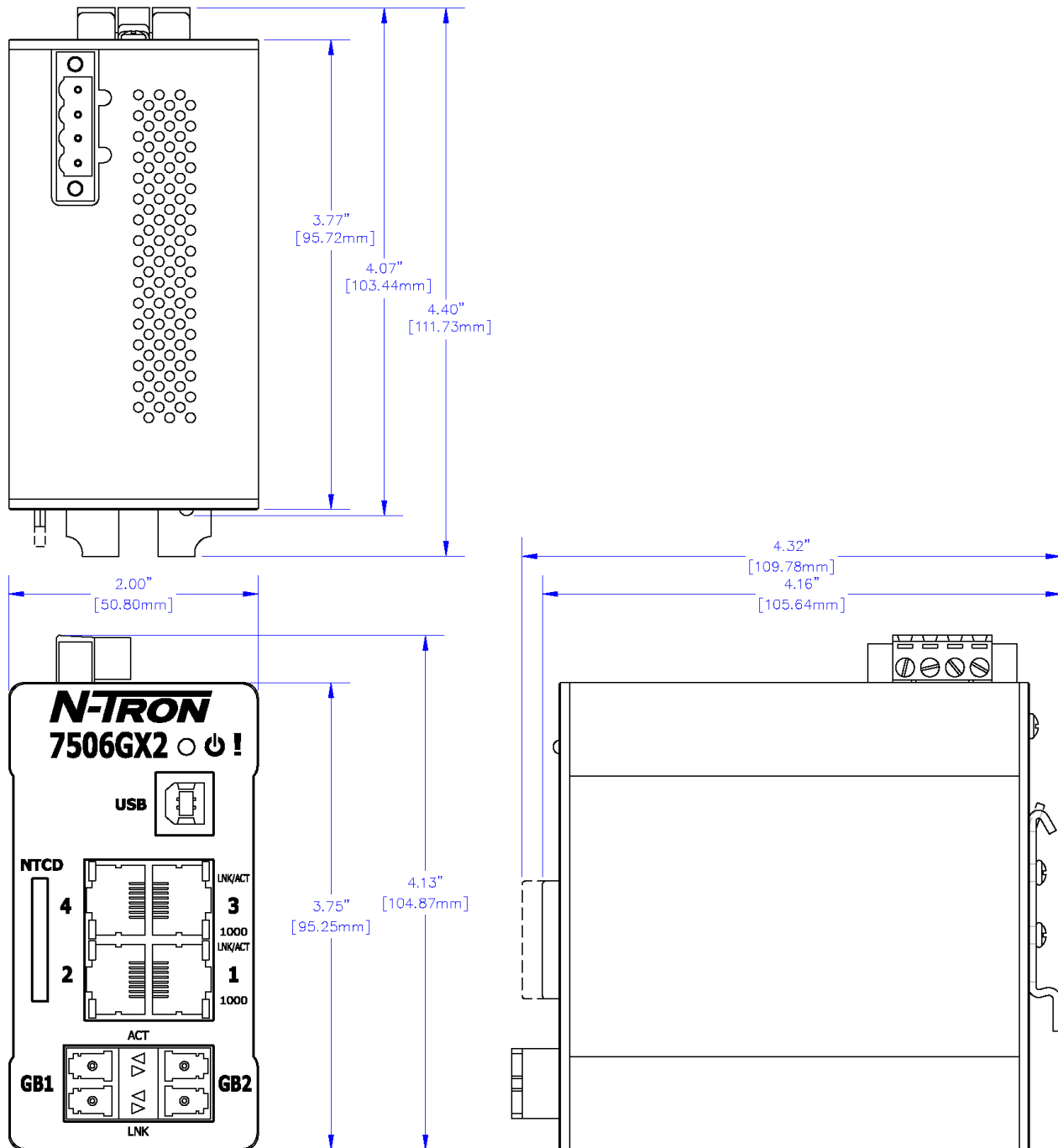

All specifications are subject to change. Consult the company website for more information.





## 1.12 7900

The 7900 Gigabit Ethernet capable Industrial Ethernet switch is a fully managed scalable switch that features two SFP Gigabit ports, available modules with six 10/100 BaseTX RJ45 copper ports, and available fiber modules having two or four 100Base ST or SC fiber ports, and redundant 10-30 VDC power inputs. Designed to handle the most demanding environments it is ideally suited for connecting Ethernet enabled industrial and security equipment.

### 1.12.1 Features and Benefits

#### Features and Benefits

Full IEEE 802.3 Compliance  
Up to 24 10/100Base-T(X) RJ45 Copper Ports  
Up to 16 100BaseFX SC or ST Duplex Ports  
Two Optional SFP (Mini-GBIC) Gigabit Transceivers

- 1000BaseSX/LX Ports, LC style
- 1000BaseT Ports, RJ45 style

Redundant 10 to 30 VDC Power Inputs

- Keeps network running in the event of a power supply failure.

-20 °C to 70 °C operating temperature  
ESD and Surge Protection Diodes on all Ports  
Autosensing 10/100BaseTX, Duplex, and MDIX  
Offers Rapid Spanning Tree Protocol  
Trunk with other N-Tron trunking capable switches over two ports  
Store & Forward Technology  
Plug-and-Play IGMP Support  
Rugged DIN-Rail Enclosure  
Onboard Temperature Sensor  
Configuration Backup via optional SD Card (NTCD-128)  
SNMP v1, v2 and v3  
Web Browsing and N-View Switch Monitoring  
Configurable Bi-Color Fault Status LED

#### Fully Managed Features Include:

- Full SNMP and Web Browser Management
- Detailed Ring Map and Fault Location Charting
- IGMP
- N-Ring™ Technology with ~30ms Healing
- N-View™ OPC Monitoring
- N-Link™ Redundant N-Ring Coupling
- 802.1Q VLAN Tagging and Port VLAN
- 802.1p QoS, Port QoS, and DSCP
- 802.1D RSTP (Rapid Spanning Tree Protocol)
- Ethernet/IP™ CIP Messaging
- LLDP (Link Layer Discovery Protocol)
- Trunking
- Port Mirroring
- DHCP Client, Server, Option 82 relay, Option 61, IP Fallback
- Local Port IP Addressing
- Port Security-MAC Address Based



### 1.12.2 7900 Specifications

Mechanical				
Height	Width	Depth	Weight	Mount
5.2" (13 cm)	9.00" (22.8 cm)	5.6" (14.2 cm)	5.0 lbs (2.27 kg)	35mm DIN-Rail
Power Input				
Input Voltage	Steady Input Current	BTU/hr		
10-30 VDC (Regulated)	1.53 A @ 24 VDC	125.3 @ 24 VDC		
Environmental				
Operating Temperature	Storage Temperature	Operating Humidity		Operating Altitude
-20°C to 70°C	-40°C to 85°C	10% to 95% (non condensing)		0 to 10,000 ft.
Shock and Vibration				
Shock	Vibration		Note	
50g @ 10ms	30g, 5-200Hz, Triaxial		Unit must be bulkhead mounted to achieve these levels.	
Connectors				
10/100BaseTX: Up to 24 RJ45 copper ports 100BaseFX: Up to 16 SC or ST duplex fiber ports Optional SFP Ports: 1000BaseT: Up to two RJ45 gigabit copper ports or, 1000BaseSX/LX: Up to two LC duplex gigabit fiber ports				
Recommended Minimum Wiring Clearance				
Side	1" (2.54 cm)			
Front	4" (10.16 cm)			
Network Media				
10BaseT	100BaseTX	1000BaseT	100BaseFX, 1000BaseSX	100BaseFXE, 1000BaseLX
≥CAT3 Cable	≥CAT5 Cable	≥CAT5E Cable	Multimode: 50-62.5/125µm	Singlemode: 7-10/125µm
Switch Properties				
Number of MAC Addresses		Aging Time	Latency (Typical)	Switching Method
8,000		Programmable	2.6 µs	Store & Forward

Refer to ["100 MB Fiber Transceiver Characteristics"](#)

Refer to ["Gigabit Fiber Transceiver \(SFP\) Characteristics"](#)



### 1.12.3 7900 Dimensions

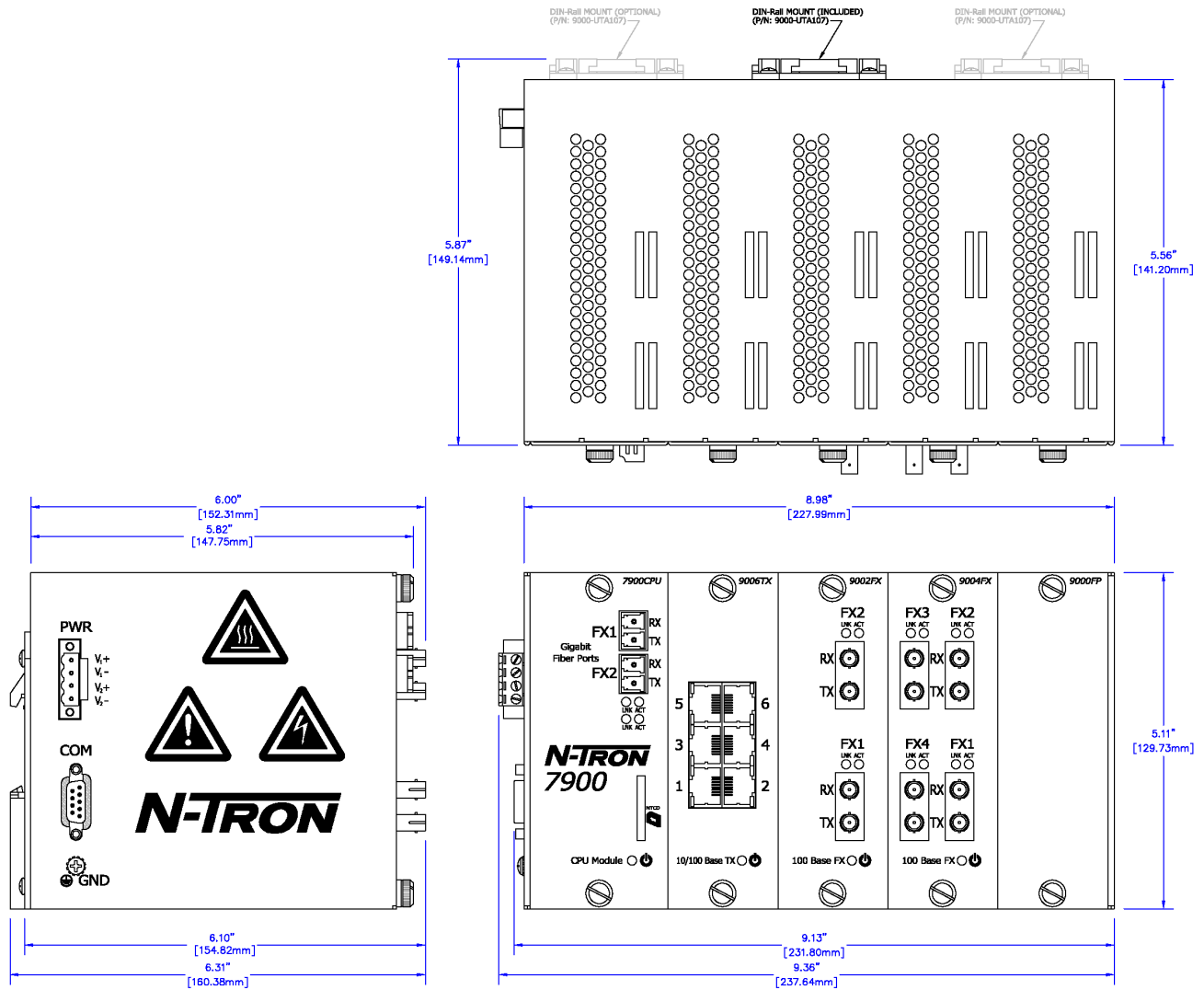

All specifications are subject to change. Consult the company website for more information.



## 1.13 Optional Panel Mount

There are five optional panel mounts available for use with the switches:

- CPMA-1
- CPMA-2
- 1000-PM
- 7026TX-PMK
- 9000-PM

### 1.13.1 Panel Mount Application

Panel Mount Application					
Switch Model	CPMA-1	CPMA-2	7026TX-PMK	1000-PM	9000-PM
709FX	x				
709FX-HV		x			
710FX2	x				
710FX2-HV		x			
711FX3	x				
711FX3-HV		x			
712FX4		x			
712FX4-HV		x			
714FX6		x			
7010TX	x				
7012FX2		x			
7012FX2-HV		x			
7026TX			x		
7506GX2				x	
7900					x

### 1.13.2 Compact Panel Mount CPMA-1 Dimensions

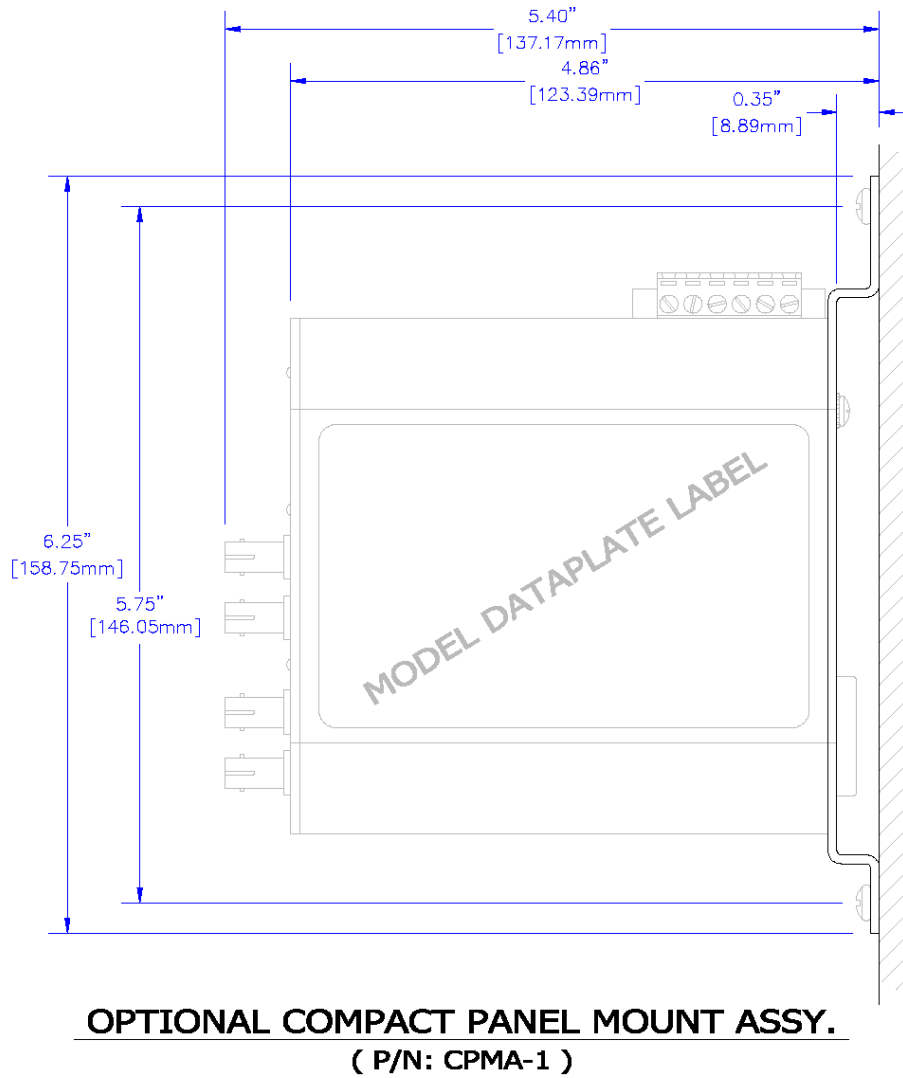

### 1.13.3 Compact Panel Mount CPMA-2 Dimensions

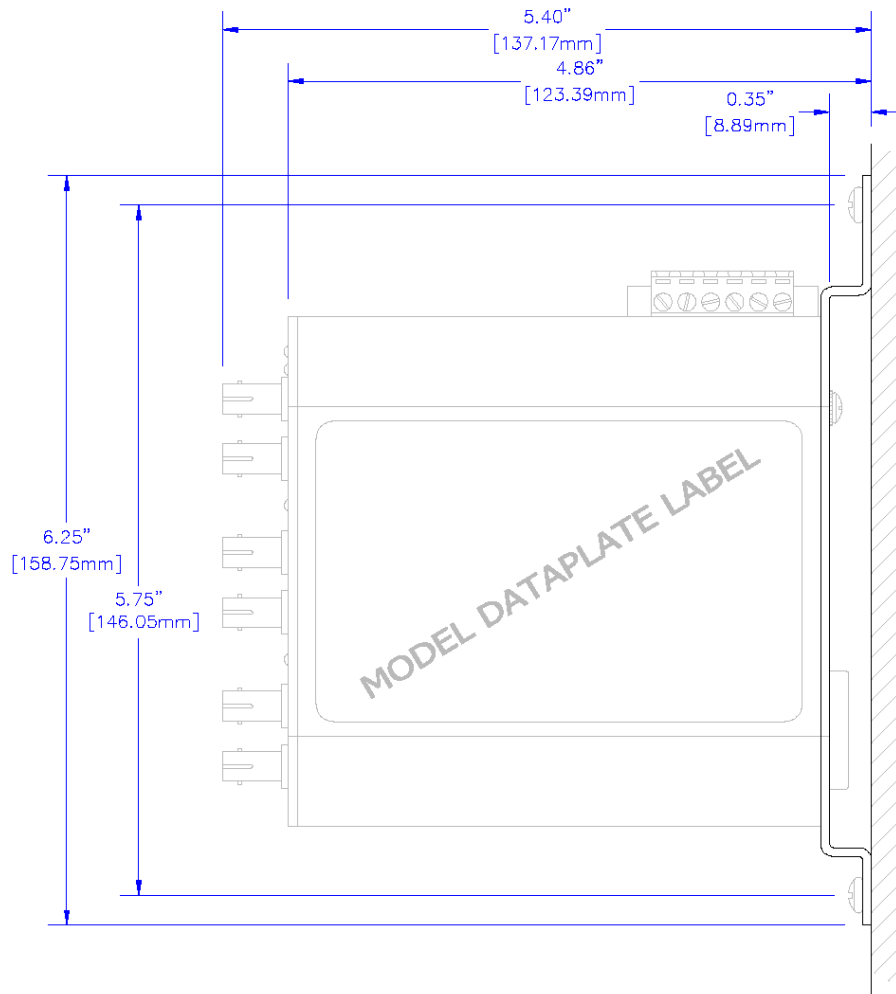

**OPTIONAL COMPACT PANEL MOUNT ASSY.**  
( P/N: CPMA-2 )

### 1.13.4 Panel Mount 9000-PM Dimensions

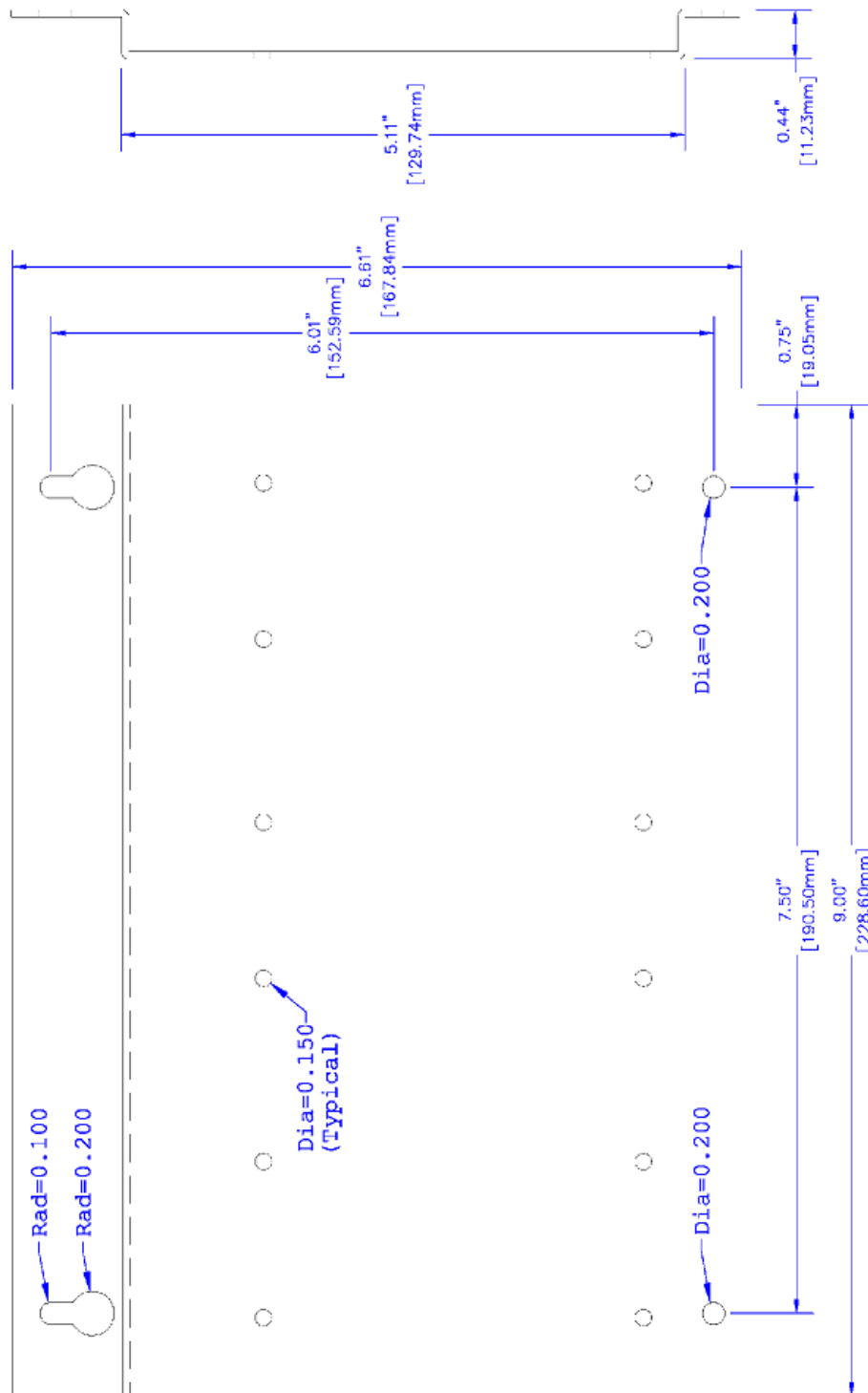

## 1.14 Transceiver Characteristics

### 1.14.1 100 MB Fiber Transceiver Characteristics

<b>Fiber Length</b>	2 km*	15 km**	40 km**	80 km**
<b>TX Power Min</b>	-19 dBm	-15 dBm	-5 dBm	-5 dBm
<b>RX Sensitivity Max</b>	-31 dBm	-31 dBm	-34 dBm	-34 dBm
<b>Wavelength</b>	1310 nm	1310 nm	1310 nm	1550 nm

\* Multimode Fiber Optic Cable

\*\* Singlemode Fiber Optic Cable

### 1.14.2 Gigabit Fiber Transceiver (SFP) Characteristics

<b>Fiber Length</b>	550 m* @ 50/125 $\mu$ m 275 m @ 62.5/125 $\mu$ m	10 km**	40 km**	80 km**
<b>TX Power Min</b>	-9.5 dBm	-9.5 dBm	-2 dBm	0 dBm
<b>RX Sensitivity Max</b>	-17 dBm	-20 dBm	-22 dBm	-24 dBm
<b>Wavelength</b>	850 nm	1310 nm	1310 nm	1550 nm
<b>Assumed Fiber Loss</b>	3.5 to 3.75 dB/km	0.45 dB/km	0.35 dB/km	0.25 dB/km
<b>Laser Type</b>	VCSEL	FP	DFB	DFB

\* SX Fiber Optic Cable

\*\* LX Fiber Optic Cable

**Note:** Fiber Length distances represent typical performance. Link budgets should be evaluated based on specific application conditions.



## 1.15 LEDs

RJ45 data ports have two LEDs located on each connector. The bottom LED (labeled LNK) indicates link status, and the top LED (labeled ACT) indicates activity.

Fiber (FX) ports have two LEDs located above each connector. The left LED (labeled LNK) indicates link status, and the right LED (labeled ACT) indicates activity.

Gigabit ports (GB) ports have two LEDs (arrows) located on each connector. The bottom LED (right pointing arrow) indicates link (LNK) status, and the top LED (left pointing arrow) indicates activity (ACT).

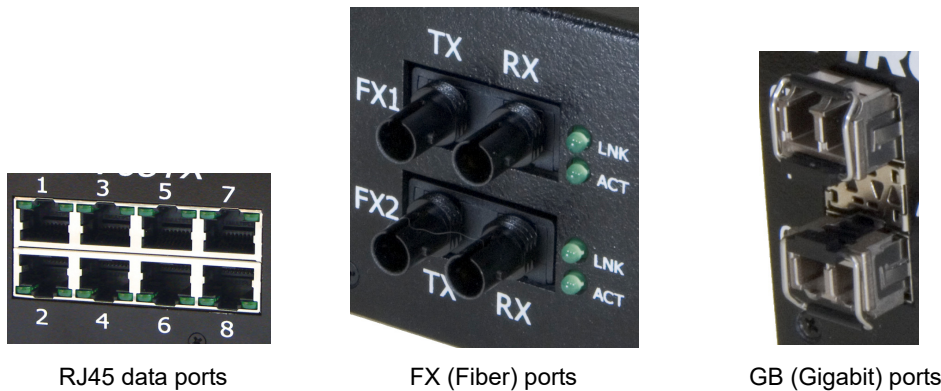

RJ45 data ports

FX (Fiber) ports

GB (Gigabit) ports

The table below describes the operating modes:

LED	Color	Description
	Green	Power is On with no active faults.
	Red	Power is On and an active fault.
	Off	Power is Off
LNK	Green	10/100/1000 Mbs Link between ports
	Off	No link established. Link is 10/100 Mbs - 7506 models.
ACT	Green (Blinking)	Link is established. Data is active between ports. Activity light blink rate indicates activity, not necessarily the volume of activity
	Off	Data is inactive between ports

## 1.16 Ordering Guide

### 1.16.1 709FX

Part Number	Description
709FX-XX-VV	Nine Port (eight 10/100Base-TX, 1 100BaseFX Fiber Uplink) Managed Industrial Ethernet Switch, DIN-Rail
709FXE-XX-YY-VV	Nine Port (eight 10/100Base-TX, 1 100BaseFX Fiber Uplink) Managed Industrial Ethernet Switch, singlemode, DIN-Rail
NTCD-128	Optional Configuration Card for backup / restore
NTPS-24-1.3	Power Supply 1.3 Amp @ 24 VDC
NTPS-48-2	Power Supply 2 Amp @ 48 VDC
CPMA-1	Compact Panel Mount (factory installed option only)
CPMA-2	Compact Panel Mount (factory installed option only) (-HV model)
URMK	19" Universal Rack Mount Kit
Where: E = Singlemode, and blank otherwise VV = HV for high voltage, blank for standard voltage XX = ST or SC connector YY = 15, 40, or 80 for Singlemode, blank for multimode	



### 1.16.2 710FX2

Part Number	Description
710FX2-XX-VV	10 Port (eight 10/100Base-TX, 2 100BaseFX Fiber Uplink) Managed Industrial Ethernet Switch, DIN-Rail
710FXE2-XX-YY-VV	10 Port (eight 10/100Base-TX, 2 100BaseFX Fiber Uplink) Managed Industrial Ethernet Switch, singlemode, DIN-Rail
NTCD-128	Optional Configuration Card for backup / restore
NTPS-24-1.3	Power Supply 1.3 Amp @ 24 VDC
NTPS-48-2	Power Supply 2 Amp @ 48 VDC
CPMA-1	Compact Panel Mount (factory installed option only)
CPMA-2	Compact Panel Mount (factory installed option only) (-HV model)
URMK	19" Universal Rack Mount Kit

Where: E = Singlemode, and blank otherwise  
 VV = HV for high voltage, blank for standard voltage  
 XX = ST or SC connector  
 YY = 15, 40, or 80 for Singlemode, blank for multimode



### 1.16.3 711FX3

Part Number	Description
711FX3-XX-VV	11 Port (eight 10/100Base-TX, 3 100BaseFX Fiber Uplink) Managed Industrial Ethernet Switch, DIN-Rail
711FXE3-XX-YY-VV	11 Port (eight 10/100Base-TX, 3 100BaseFX Fiber Uplink) Managed Industrial Ethernet Switch, singlemode, DIN-Rail
NTCD-128	Optional Configuration Card for backup / restore
NTPS-24-1.3	Power Supply 1.3 Amp @ 24 VDC
NTPS-48-2	Power Supply 2 Amp @ 48 VDC
CPMA-1	Compact Panel Mount (factory installed option only)
CPMA-2	Compact Panel Mount (factory installed option only) (-HV model)
URMK	19" Universal Rack Mount Kit

Where: E = Singlemode, and blank otherwise  
 VV = HV for high voltage, blank for standard voltage  
 XX = ST or SC connector  
 YY = 15, 40, or 80 for Singlemode, blank for multimode



### 1.16.4 712FX4

Part Number	Description
712FX4-XX-VV	12 Port (eight 10/100Base-TX, 4 100BaseFX Fiber Uplink) Managed Industrial Ethernet Switch, DIN-Rail
712FXE4-XX-YY-VV	12 Port (eight 10/100Base-TX, 4 100BaseFX Fiber Uplink) Managed Industrial Ethernet Switch, singlemode, DIN-Rail
NTCD-128	Optional Configuration Card for backup / restore
NTPS-24-1.3	Power Supply 1.3 Amp @ 24 VDC
NTPS-48-2	Power Supply 2 Amp @ 48 VDC
CPMA-2	Compact Panel Mount (factory installed option only)
URMK	19" Universal Rack Mount Kit

Where: E = Singlemode, and blank otherwise  
 VV = HV for high voltage, blank for standard voltage  
 XX = ST or SC connector  
 YY = 15, 40, or 80 for Singlemode, blank for multimode



### 1.16.5 714FX6

Part Number	Description
714FX6-XX	14 Port (eight 10/100Base-TX, 6 100BaseFX Fiber Uplink) Managed Industrial Ethernet Switch, DIN-Rail
714FXE6-XX-YY	14 Port (eight 10/100Base-TX, 6 100BaseFX Fiber Uplink) Managed Industrial Ethernet Switch, singlemode, DIN-Rail
NTCD-128	Optional Configuration Card for backup / restore
NTPS-24-1.3	Power Supply 1.3 Amp @ 24 VDC
CPMA-2	Compact Panel Mount (factory installed option only)
URMK	19" Universal Rack Mount Kit

Where: E = Singlemode, and blank otherwise  
 XX = ST or SC connector  
 YY = 15, 40, or 80 for Singlemode, blank for multimode



### 1.16.6 7010TX

Part Number	Description
7010TX	Eight Port (eight 10/100Base-TX, two optional gigabit SFP ports, Managed Industrial Ethernet Switch, DIN-Rail
NTSFP-TX	1000BaseT copper SFP (Mini-GBIC) Transceiver (RJ45 connector)
NTSFP-SX	1000BaseSX multimode fiber SFP (Mini-GBIC) Transceiver (LC style connector)
NTSFP-LX-ZZ	1000BaseLX singlemode fiber SFP (Mini-GBIC) Transceiver (LC style connector)
NTCD-128	Optional Configuration Card for backup / restore
NTPS-24-1.3	Power Supply 1.3 Amp @ 24 VDC
CPMA-1	Compact Panel Mount (factory installed option only)
URMK	19" Universal Rack Mount Kit

Where: ZZ = 10,40, or 80 for GB Singlemode  
 If SFP Transceiver is not specified at the time of purchase, slots will remain blank with covers.





### 1.16.7 7012FX2

Part Number	Description
7012FX2-XX-VV	12 Port (eight 10/100Base-TX, two 100BaseFX fiber, and two SFP Mini-GBIC fiber expansion ports) Managed Industrial Ethernet Switch, DIN-Rail
7012FXE2-XX-YY-VV	12 Port (eight 10/100Base-TX, two 100BaseFX fiber, and two SFP Mini-GBIC fiber expansion ports) Managed Industrial Ethernet Switch, DIN-Rail
NTSFP-TX	1000BaseT copper SFP (Mini-GBIC) Transceiver (RJ45 connector)
NTSFP-SX	1000BaseSX multimode fiber SFP (Mini-GBIC) Transceiver (LC style connector)
NTSFP-LX-ZZ	1000BaseLX singlemode fiber SFP (Mini-GBIC) Transceiver (LC style connector)
NTCD-128	Optional Configuration Card for backup / restore
NTPS-24-1.3	Power Supply 1.3 Amp @ 24 VDC
NTPS-48-2	Power Supply 2 Amp @ 48 VDC
CPMA-2	Compact Panel Mount (factory installed option only)
URMK	19" Universal Rack Mount Kit

Where: E = Singlemode, and blank otherwise  
 VV = HV for high voltage, blank for standard voltage  
 XX = ST or SC connector  
 YY = 15, 40, or 80 for Singlemode, blank for multimode  
 ZZ = 10, 40, or 80 for GB Singlemode  
 If SFP transceiver is not specified at the time of purchase, slots remain blank with covers.





### 1.16.8 7026TX

Part Number	Description
7026TX	26 Port (24 10/100Base-TX, two 1000Base SFP Mini-GBIC expansion ports) Managed Industrial Ethernet Switch, 19" rackmount
7026TX-AC	26 Port (24 10/100Base-TX, two 1000Base SFP Mini-GBIC expansion ports) Managed Industrial Ethernet Switch, 19" rackmount, 90-264 VAC / 90-300 VDC power input
NTSFP-TX	1000BaseT copper SFP (Mini-GBIC) Transceiver (RJ45 connector)
NTSFP-SX	1000BaseSX multimode fiber SFP (Mini-GBIC) Transceiver (LC style connector)
NTSFP-LX-ZZ	1000BaseLX singlemode fiber SFP (Mini-GBIC) Transceiver (LC style connector)
NTCD-128	Optional Configuration Card for backup / restore
NTPS-24-1.3	Power Supply 1.3 Amp @ 24 VDC
7026TX-PMK	Panel mount kit

Where ZZ = 10, 40, or 80 for GB Singlemode  
 If SFP Transceiver is not specified at the time of purchase, slots will remain blank with covers.



### 1.16.9 7506GX2

Part Number	Description
7506GX2	Four 10/100/1000Base-T(X), two SFP ports without (optional) modules Managed Industrial Ethernet Switch, DIN-Rail
7506GX2-SX	Four 10/100/1000Base-T(X), two SFP ports with two NTSFP-SX multimode modules installed Managed Industrial Ethernet Switch, DIN-Rail
7506GX2-LX-10	Four 10/100/1000Base-T(X), two SFP ports with two NTSFP-LX-10 singlemode modules installed Managed Industrial Ethernet Switch, DIN-Rail
NTSFP-TX	1000BaseT copper SFP (Mini-GBIC) Transceiver (RJ45 connector)
NTSFP-SX	1000BaseSX multimode fiber SFP (Mini-GBIC) Transceiver (LC style connector)
NTSFP-LX-ZZ	1000BaseLX singlemode fiber SFP (Mini-GBIC) Transceiver (LC style connector)
NTCD-128	Optional Configuration Card for backup / restore
NTPS-24-1.3	Power Supply 1.3 Amp @ 24 VDC
1000-PM	Panel Mount Kit
URMK	19" Universal Rack Mount Kit

Where ZZ = 10, 40, or 80 for GB Singlemode  
If SFP Transceiver is not specified at the time of purchase, slots will remain blank with covers.



1.16.10 7900

Part Number	Description
7900CPU	CPU module with two gigabit SFP ports - transceivers sold separately
9000BP	Five slot backplane (requires 7900CPU module - sold separately), DIN-Rail
9006TX	Six 10/100Base-TX copper port slide-in module
9002FX-XX	Two 100Base-FX multimode fiber port slide-in module
9002FXE-XX-YY	Two 100Base-FX singlemode fiber port slide-in module
9004FX-XX	Four 100Base-FX multimode fiber port slide-in module
9004FXE-XX-YY	Four 100Base-FX singlemode fiber port slide-in module
NTSFP-TX	1000BaseT copper SFP (Mini-GBIC) Transceiver (RJ45 connector)
NTSFP-SX	1000BaseSX multimode fiber SFP (Mini-GBIC) Transceiver (LC style connector)
NTSFP-LX-ZZ	1000BaseLX singlemode fiber SFP (Mini-GBIC) Transceiver (LC style connector)
NTCD-128	Optional Configuration Card for backup / restore
NTPS-24-5	Power Supply 5 Amp @ 24 VDC
9000B-FP	Filler Panel (required to fill vacant slots)
9000-PM	Panel mount kit
9000-UTA107	Metal DIN-Rail clip; one included, can accommodate two additional clips-3 total-for increased stability

Where: E = Singlemode, and blank otherwise

XX = ST or SC connector

YY = 15, 40, or 80 for Singlemode, blank for multimode

ZZ = 10, 40, or 80 for GB Singlemode

If SFP transceiver is not specified at the time of purchase, slots remain blank with covers.



# Chapter 2 Hardware Installation

## 2.1 Unpacking

Remove all the equipment from the packaging and store the packaging in a safe place. File any damage claims with the carrier.

Make certain the N-Tron® Series 700/7000 Ethernet Switch package contains the following items:

1. 700/7000 switch
2. Product CD

## 2.2 Mounting the Switch

Red Lion offers several panel mount options which may be used to securely mount the 700/7000 models to a panel or other flat surface. Refer to section 1.13 to determine which panel mount option will work with your switch.

The proper clearance should be observed on the sides, back, top and bottom to allow proper ventilation. Also, observe the proper cable bend radius for the front and top side of the unit.

### 2.3.1 DIN-Rail Mounting Instructions 709FX, 710FX2, 711FX3, 712FX4, 714FX6, 7010TX, 7012FX2, 7506GX2, and 7900 Models

Install the unit on a standard 35mm Din-Rail. Recess the unit to allow at least 3" of horizontal clearance for copper cable bend radius. Recess the unit to allow at least 5" of horizontal clearance for fiber cable bend radius. There should be at least 3" of clearance on both the top and bottom of the unit to allow proper ventilation.

#### 2.3.1.1 Mounting

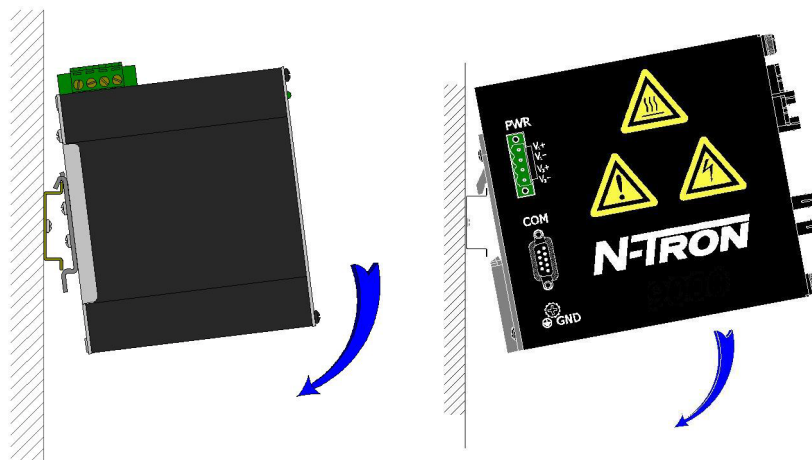

Install the switch to standard 35mm DIN-Rail as shown in the diagram above.

1. Hook the top of the DIN-Rail clip on the back of the switch to the rail at an upward angle.

2. Then, gently rotate the front of the switch downward, towards the panel.
3. Push the bottom of the switch towards the rail until it locks into place.
4. Apply upward force to verify the switch is securely installed.
5. Connect any communications cables to the switch.
6. Install the power and ground wires.
7. Apply power to the power supply.

### 2.3.2 DIN-Rail Removal Instructions 709FX, 710FX2, 711FX3, 712FX4, 714FX6, 7010TX, 7012FX2, and 7506GX2 Models

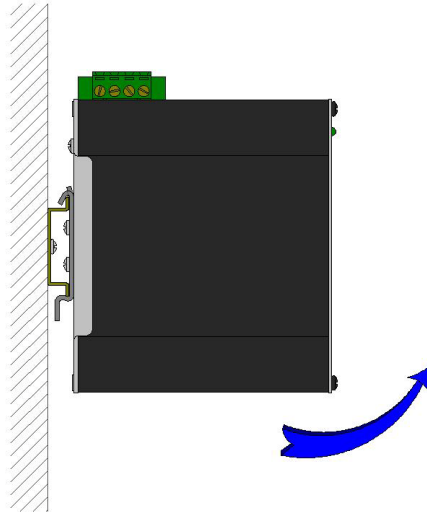

Remove the switch from standard 35mm DIN-Rail as shown in the diagram above.

1. Ensure power from the power source is off.
2. Disconnect power and ground wires.
3. Disconnect any communications cables from the unit.
4. Pull forward on the bottom of the unit until it disengages from the bottom of the DIN-Rail.
5. Carefully lift the switch upward and away from the DIN-Rail and panel.

### 2.3.3 DIN-Rail Removal Instructions 7900 Model

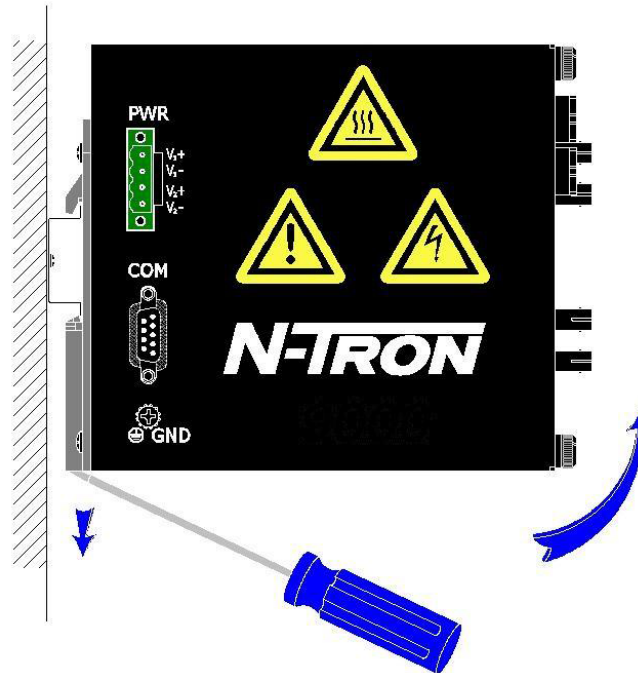

Remove the switch from standard 35mm DIN-Rail as shown in the diagram above.

1. Ensure power from the power source is off.
2. Disconnect power and ground wires.
3. Disconnect any communications cables from the unit.
4. Insert a standard flat/slotted screwdriver into the slot provided on the DIN-Rail clip.
5. Using the base of the switch as a pivot point, apply upward force on the screwdriver to release the DIN-Rail clip.
6. With the DIN-Rail clip latching mechanism released, continue to rotate the switch upward and away from the panel.
7. Once the switch has been rotated upward, remove the screwdriver.
8. Carefully lift the switch upward and away from the DIN-Rail and panel.

### 2.3.4 Rack and Panel Mounting Instructions 709FX, 710FX2, 711FX3, 712FX4, 714FX6, 7010TX, 7012FX2, 7506GX2, and 7900 Models

Most of the switches are designed to be mounted on a standard 35mm Din-Rail. However, in the event that Din-Rail mounting is not suitable for the application the optional Universal Rack Mount Kit (P/N: URMK) can be used to mount the switch to standard 19" racks. Optional panel mounts are available if the application requires mounting the switch to a panel or other flat surface. For the 709FX, 710FX2, 711FX3, 712FX4, 714FX6, 7010TX, and 7012FX2 models, the optional Panel Mount Assembly (P/N: CMPA-1 or CPMA-2) is factory installed.

### 2.3.4.1 Rack Mounting 709FX, 710FX2, 711FX3, 712FX4, 714FX6, 7010TX, 7012FX2, 7506GX2, and 7900 Models

Attach the Universal Rack Mount to the switch as shown in the diagram and install the switch in a standard 19" rack.



1. While supporting the unit, align the mounting brackets slots with the rack mounting holes.
2. Insert a mounting screw into the rack mounting hole through the right or left mounting bracket and hand tighten. Repeat on the other side.
3. Finish tightening the first two mounting screws and install the remaining two mounting screws securing the unit to the rack.
4. Connect any communications cables to the switch.
5. Install the power and ground wires.
6. Apply power to the power supply.

### 2.3.4.2 Panel Mounting 709FX, 710FX2, 711FX3, 712FX4, 714FX6, 7010TX, 7012FX2, 7506GX2, and 7900 Models

Install the switch in a flat panel or other flat surface.

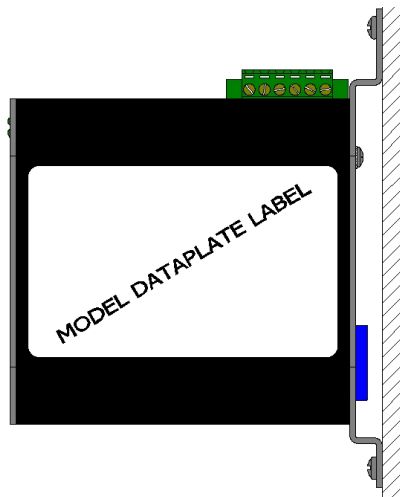

1. For the 709FX, 710FX2, 711FX3, 712FX4, 714FX6, 7010TX, and 7012FX2, models ensure the CPMA mounting bracket was factory installed on the switch.
2. While supporting the unit, align the mounting brackets slots with the desired installation location on the flat surface.
3. Mark the mounting brackets slot locations.
4. Drill a hole at each marked location
5. While supporting the unit, align the mounting brackets slots with the drilled mounting holes.
6. Insert a mounting screw through the right or left mounting bracket and hand tighten. Repeat on the other side.
7. Finish tightening the first two mounting screws and install the remaining two mounting screws securing the unit.
8. Connect any communications cables to the switch.
9. Install the power and ground wires.
10. Apply power to the power supply.

### 2.3.5 Rack and Panel Mounting Instructions for 7026TX Model

The 7026TX model is preconfigured with standard rack mount brackets used to mount the unit to standard 19" racks. As an alternative we offer the 7026TX Panel Mount Assembly (P/N: 7026TX-PMK) used to securely mount the unit to a panel or other flat surface.

A clearance of 1 inch should be observed on the sides, back, top and bottom to allow proper ventilation. Also, a cable bend radius of 2 inches should be observed for the front and back side of the unit.

#### 2.3.5.1 Rack Mounting 7026TX Model

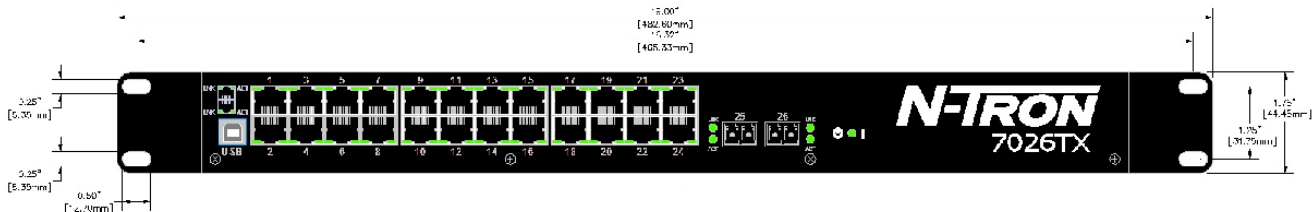

Install the switch in a standard 19" rack using the mounting holes as shown in the diagram above.

1. While supporting the unit, align the mounting brackets slots with the rack mounting holes.
2. Insert a mounting screw into the rack mounting hole through the right or left mounting bracket and hand tighten. Repeat on the other side.
3. Finish tightening the first two mounting screws and install the remaining two mounting screws securing the unit to the rack.
4. Connect any communications cables to the switch.
5. Install the power and ground wires.
6. Apply power to the power supply.



### 2.3.5.2 Panel Mounting 7026TX Model

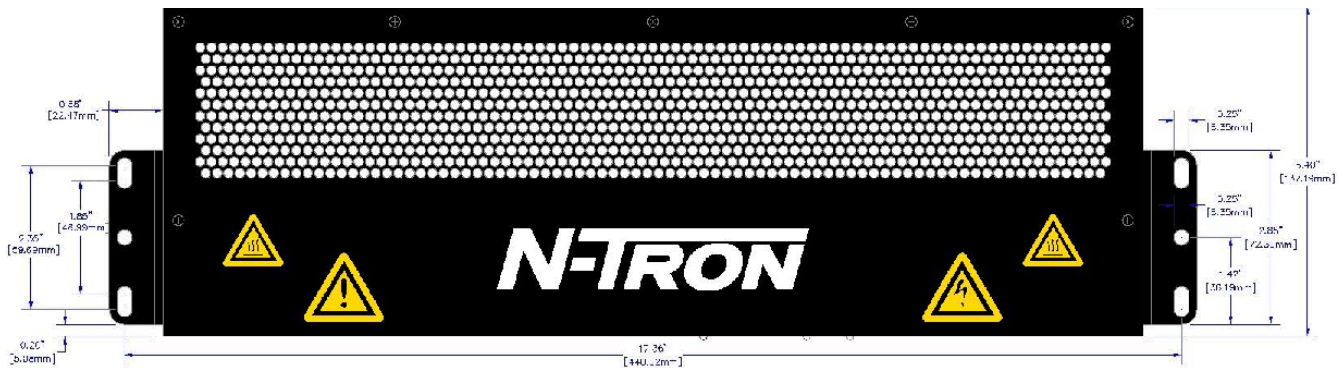

Install the switch on a panel using the mounting bracket holes as shown in the diagram above.

1. Attach the mounting brackets from 7026TX Panel Mount Assembly (P/N: 7026TX-PMK) to the switch.
2. While supporting the unit, align the mounting brackets slots with the desired installation location on the flat surface.
3. Mark the mounting brackets slot locations.
4. Drill a hole at each marked location
5. While supporting the unit, align the mounting brackets slots with the drilled mounting holes.
6. Insert a mounting screw through the right or left mounting bracket and hand tighten. Repeat on the other side.
7. Finish tightening the first two mounting screws and install the remaining two mounting screws securing the unit.
8. Connect any communications cables to the switch.
9. Install the power and ground wires.
10. Apply power to the power supply.

## 2.4 Connect Power Source

### 2.4.1 709FX, 710FX2, 711FX3, 712FX4, 714FX6, 7010TX and 7012FX2 Models

The 7xx models have a redundant 10-49 VDC power input (HV (High Voltage) 43-300 VDC options are available for some models).

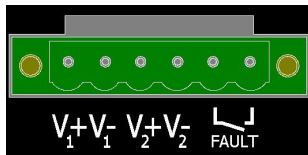
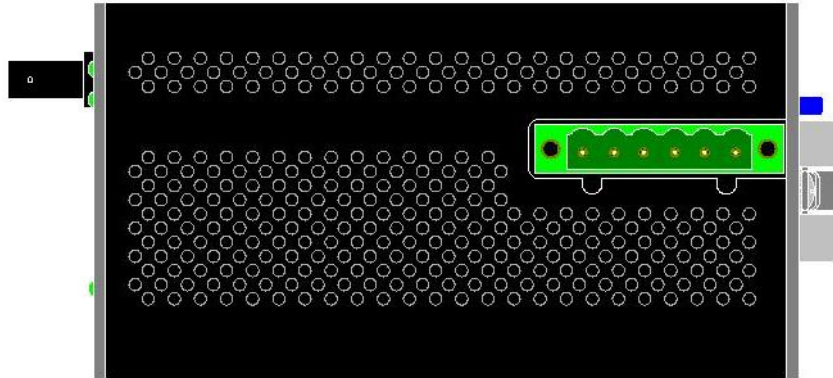

1. Unscrew and remove the DC voltage input plug from the power input header.
2. Install the DC power cables into the plug (observing polarity).
3. Plug the voltage input plug back into the power input header. This is the power disconnect device that must be removed before performing any kind of service or maintenance on the device.
4. Tightening torque for the terminal block power plug is 0.5 Nm/0.368 lb/ft.
5. Verify that the power LED is on (Green).

**Note:** When a DC power supply is installed, only one power supply must be connected to power for minimal operation. For redundant power operation, V1 and V2 inputs must be connected to separate DC voltage sources. This unit will draw current from both sources simultaneously. Use 16-28 AWG (0.08mm<sup>2</sup> - 1.31mm<sup>2</sup>) wire when connecting to the power supply.

**Note:** The Fault pins on the power connector can be used for an alarm contact. The current carrying capacity is 1A at 24VDC. It is normally open and the relay closes when a fault condition occurs. These pins can be used to connect an external warning device such as a light in order to provide an external alarm. The conditions for generating a fault condition (closing the relay) can be configured through software.

Recommended 24 VDC power supply, similar to Red Lion's P/N NTPS-24-1.3.

For -HV models, recommended 48 VDC power supply, similar to Red Lion's P/N NTPS-48-2.

Verify that the proper input voltage is connected to the switch before powering on the unit.

**Note:** LEDs are described in detail in [“LEDs” on page 42](#).

### 2.4.2 7026TX

The 7026TX has a redundant 18-49 VDC power input.

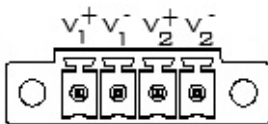

1. Unscrew and remove the DC voltage input plug from the power input header.
2. Install the DC power cables into the plug (observing polarity).
3. Plug the voltage input plug back into the power input header. This is the power disconnect device that must be removed before performing any kind of service or maintenance on the device.
4. Tightening torque for the terminal block power plug is 0.5 Nm/0.368 lb/ft.
5. Verify that the power LED is on (Green).

**Note:** When a DC power supply is installed, only one power supply must be connected to power for minimal operation. For redundant power operation, V1 and V2 inputs must be connected to separate DC voltage sources. This unit will draw current from both sources simultaneously. Use 16-28 AWG (0.08mm<sup>2</sup> - 1.31mm<sup>2</sup>) wire when connecting to the power supply.

Recommended 24 VDC power supply, similar to Red Lion's P/N NTPS-24-1.3.

Verify that the proper input voltage is connected to the switch before powering on the unit.

**Note:** LEDs are described in detail in [“LEDs” on page 42](#).

### 2.4.3 7026TX-AC

The 7026TX-AC has 90-264 VAC/90-300 VDC power input.

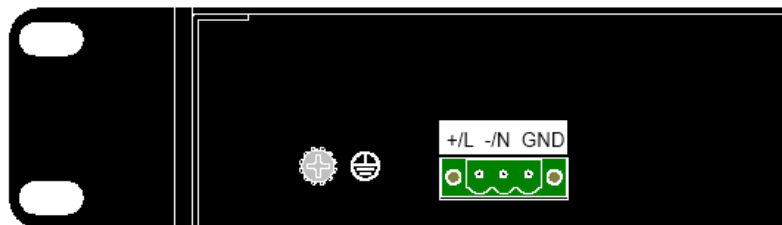



1. Unscrew and remove the AC voltage input plug from the power input header.
2. Install the AC power cables into the plug (observing polarity).
3. Plug the voltage input plug back into the power input header. This is the power disconnect device that must be removed before performing any kind of service or maintenance on the device.
4. Tightening torque for the terminal block power plug is 0.5 Nm/0.368 lb/ft.
5. Verify that the power LED is on (Green).

**Note:** When a AC power supply is installed (i.e., the -AC option), use 12-24 AWG (0.205mm<sup>2</sup> - 3.31mm<sup>2</sup>) wire when connecting to the power supply.

Verify that the proper input voltage is connected to the switch before powering on the unit.

**Note:** LEDs are described in detail in [“LEDs” on page 42](#).

#### 2.4.4 7506GX2

The 7506GX2 has a redundant 10-49 VDC power input.

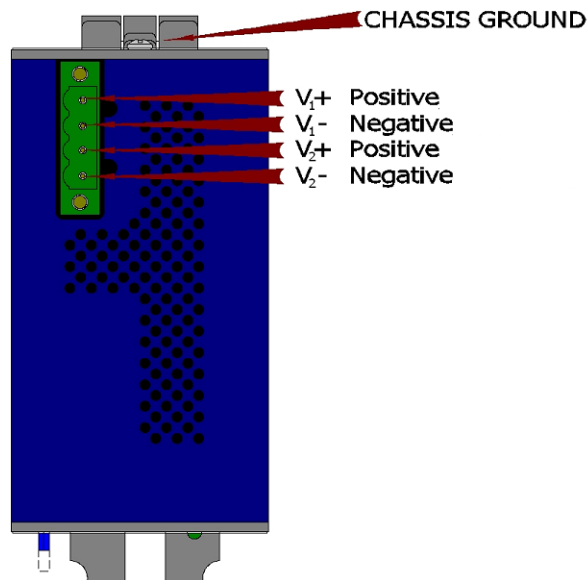

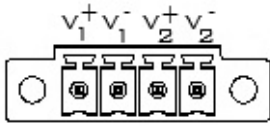

1. Unscrew and remove the DC voltage input plug from the power input header.
2. Install the DC power cables into the plug (observing polarity).
3. Plug the voltage input plug back into the power input header. This is the power disconnect device that must be removed before performing any kind of service or maintenance on the device.
4. Tightening torque for the terminal block power plug is 0.5 Nm/0.368 lb/ft.
5. Verify that the power LED is on (Green).

**Note:** When a DC power supply is installed, only one power supply must be connected to power for minimal operation. For redundant power operation, V1 and V2 inputs must be connected to separate DC voltage sources. This unit will draw current from both sources simultaneously. Use 16-28 AWG (0.08mm<sup>2</sup> - 1.31mm<sup>2</sup>) wire when connecting to the power supply.

Recommended 24 VDC power supply, similar to Red Lion's P/N NTPS-24-1.3.

Verify that the proper input voltage is connected to the switch before powering on the unit.

**Note:** LEDs are described in detail in [“LEDs” on page 42](#).

#### 2.4.5 7900

The 7900 has a redundant 10-30 VDC power input.



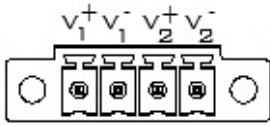

1. Unscrew and remove the DC voltage input plug from the power input header.
2. Install the DC power cables into the plug (observing polarity).
3. Plug the voltage input plug back into the power input header. This is the power disconnect device that must be removed before performing any kind of service or maintenance on the device.
4. Tightening torque for the terminal block power plug is 0.5 Nm/0.368 lb/ft.
5. Verify that the power LED is on (Green).

**Note:** When a DC power supply is installed, only one power supply must be connected to power for minimal operation. For redundant power operation, V1 and V2 inputs must be connected to separate DC voltage sources. This unit will draw current from both sources simultaneously. Use 16-28 AWG (0.08mm<sup>2</sup> - 1.31mm<sup>2</sup>) wire when connecting to the power supply.

Recommended 24 VDC power supply, similar to Red Lion's P/N NTPS-24-5.

Verify that the proper input voltage is connected to the switch before powering on the unit.

**Note:** LEDs are described in detail in [“LEDs” on page 42.](#)

## 2.5 Grounding the Switch

The grounding of any control system is an integral part of the design. Red Lion switches are designed to be grounded, but the user has been given the flexibility to float the switch when required. The best noise immunity and emissions (i.e. CE) are obtained when the Red Lion switch chassis is connected to earth ground via a drain wire (20 gauge (0.518mm<sup>2</sup>) minimum size wire). Some Red Lion switches have metal DIN-Rail brackets that can ground the switch if the DIN-Rail is grounded. In some cases, Red Lion switches with metal brackets can be supplied with optional plastic brackets if isolation is required.

### 2.5.1 Grounding 709FX, 710FX2, 711FX3, 712FX4, 714FX6, 7010TX and 7012FX2 Models

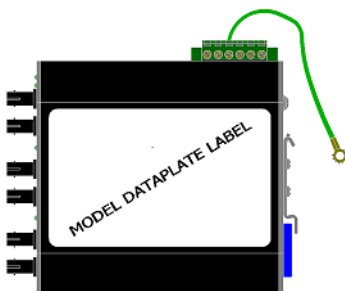

Both V- legs of the power input connector are connected to chassis internally on the PCB. Connecting a drain wire to earth ground from one of the V- terminal plugs as shown here will ground the switch and the chassis. The power leads from the power source should be limited to 3 meters or less in length.

As an alternate, users can run a drain wire & lug from the screw provided on the back of the enclosure. In the event the provided grounding screw is lost, care should be taken to limit the penetration of the outer skin by less than 1/4 in.

**Note:** Recommend using a #6 32 X1/4" Phillips pan head zinc screw. Failure to do so may cause irreversible damage to the internal components of the switch.

**Note:** Before applying power to the grounded switch, you should use a volt meter to verify there is no voltage difference between the power supply's negative output terminal and the switch chassis grounding point.

**Remarque:** Avant de mettre sous tension le commutateur de mise à la terre, vous utilisez un voltmètre pour vérifier qu'il n'y a pas de différence de tension entre l'alimentation de la borne de sortie négative et le commutateur de point de mise à la masse du châssis.



If the use of shielded cables is required, it is generally recommended to only connect the shield at one end to prevent ground loops and interfere with low level signals (i.e. thermocouples, RTD, etc.). CAT5E cables manufactured to EIA-568A or 568B specifications are required for use with Red Lion Switches.

In the event all CAT5E patch cable distances are small (i.e. All Ethernet devices are located in the same local cabinet and/or referenced to the same earth ground), it is permissible to use fully shielded cables terminated to chassis ground at both ends in systems void of low level analog signals.

### 2.5.2 Grounding 7026TX and 7026TX-AC Models

For both the DC and AC power supply options for the 7026TX/7026TX-AC the power supply is isolated from chassis ground. Therefore the user must not attempt to ground the switch to earth ground via the power supply. In other N-Tron switches it is common to use the V- for the purpose of grounding. This must NOT be attempted in the 7026TX or 7026TX-AC.

In the case of the AC power supply option (i.e., 7026TX-AC) the chassis can be connected to earth ground using the safety input of the input power plug labeled "GND" (refer to the drawing in 2.4.3 that shows the pin-out of the AC power plug) or using the ground lug located at the rear of the chassis (see adjacent illustration).

In the case of the 7026TX, the only viable safety ground option is using the ground lug at the rear of the chassis (see adjacent illustration)

If the use of shielded cables is required, it is generally recommended to only connect the shield at one end to prevent ground loops and interfere with low level signals (i.e. thermocouples, RTD, etc.). CAT5E cables manufactured to EIA-568A or 568B specifications are required for use with Red Lion Switches.

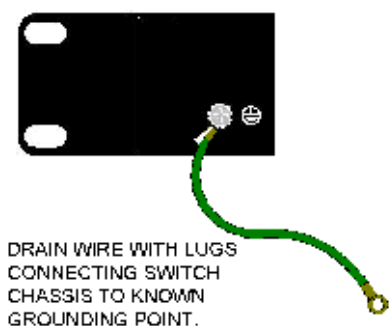

In the event all CAT5E patch cable distances are small (i.e. All Ethernet devices are located in the same local cabinet and/or referenced to the same earth ground), it is permissible to use fully shielded cables terminated to chassis ground at both ends in systems void of low level analog signals.

### 2.5.3 Grounding 7506GX2

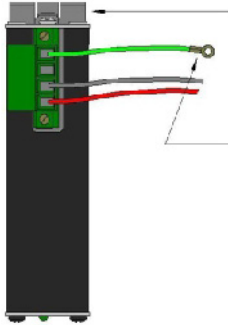

Both V- legs of the power input connector are connected to chassis internally on the PCB. Connecting a drain wire to earth ground from one of the V- terminal plugs as shown here will ground the switch and the chassis. The power leads from the power source should be limited to 3 meters or less in length.

As an alternate, users can run a drain wire & lug from the screw provided on the back of the enclosure. In the event the provided grounding screw is lost, care should be taken to limit the penetration of the outer skin by less than 1/4 in.

**Note:** Recommend using a #6 32 x 1/4" Phillips pan head zinc screw. Failure to do so may cause irreversible damage to the internal components of the switch.

**Note:** Before applying power to the grounded switch, you should use a volt meter to verify there is no voltage difference between the power supply's negative output terminal and the switch chassis grounding point.

**Remarque:** Avant de mettre sous tension le commutateur de mise à la terre, vous utilisez un voltmètre pour vérifier qu'il n'y a pas de différence de tension entre l'alimentation de la borne de sortie négative et le commutateur de point de mise à la masse du châssis.

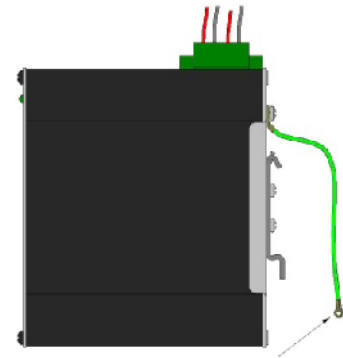

If the use of shielded cables is required, it is generally recommended to only connect the shield at one end to prevent ground loops and interfere with low level signals (i.e. thermocouples, RTD, etc.). CAT5E cables manufactured to EIA-568A or 568B specifications are required for use with Red Lion Switches.

In the event all CAT5E patch cable distances are small (i.e. All Ethernet devices are located in the same local cabinet and/or referenced to the same earth ground), it is permissible to use fully shielded cables terminated to chassis ground at both ends in systems void of low level analog signals.



## 2.5.4 Grounding 7900 Models

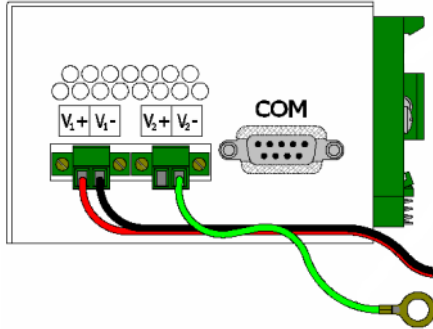

Both V- legs of the power input connector are connected to chassis internally on the PCB. Connecting a drain wire to earth ground from one of the V- terminal plugs as shown here will ground the switch and the chassis. The power leads from the power source should be limited to 3 meters or less in length.

As an alternate, users can run a drain wire & lug from the screw provided on the side of the enclosure. In the event the provided grounding screw is lost, care should be taken to limit the penetration of the outer skin by less than 1/4 in.

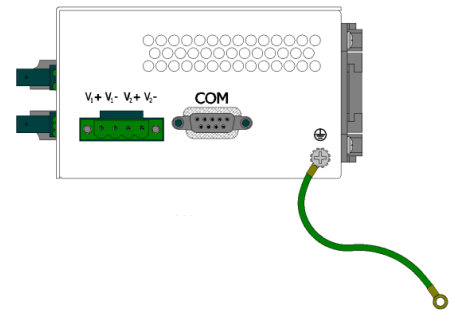

**Note:** Recommend using a #6 32 x 1/4" Phillips pan head zinc screw. Failure to do so may cause irreversible damage to the internal components of the switch.

**Note:** Before applying power to the grounded switch, you should use a volt meter to verify there is no voltage difference between the power supply's negative output terminal and the switch chassis grounding point.

**Remarque:** Avant de mettre sous tension le commutateur de mise à la terre, vous utilisez un voltmètre pour vérifier qu'il n'y a pas de différence de tension entre l'alimentation de la borne de sortie négative et le commutateur de point de mise à la masse du châssis.

If the use of shielded cables is required, it is generally recommended to only connect the shield at one end to prevent ground loops and interfere with low level signals (i.e. thermocouples, RTD, etc.). CAT5E cables manufactured to EIA-568A or 568B specifications are required for use with Red Lion Switches.

In the event all CAT5E patch cable distances are small (i.e. All Ethernet devices are located in the same local cabinet and/or referenced to the same earth ground), it is permissible to use fully shielded cables terminated to chassis ground at both ends in systems void of low level analog signals.

## 2.6 Connecting the Switch

### 2.6.1 Connecting 709FX, 710FX2, 711FX3, 712FX4, 714FX6, 7010TX, 7012FX2, 7026TX and 7900 Models

For FX/FXE units, remove the dust cap from the fiber optic connectors and connect the fiber optic cables. The TX port on the FX/FXE models should be connected to the RX port of the far end station. The RX port on the FX/FXE versions should be connected to the TX port of the far end station.

For 10/100 Base-TX ports, plug a Category 5E twisted pair cable into the RJ45 connector. Connect the other end to the far end station. Verify that the LNK LEDs are ON once the connection has been completed. To connect any port to another device (end node, Switch or Repeater), use a standard Category 5E straight through or crossover cable with a minimum length of one meter and a maximum length of 100 meters.

Red Lion recommends using pre-manufactured CAT5E cables to ensure the best performance. If this is not an option and users must terminate their own ends on the CAT5E cables; one of the two color coded standards shown to the right should be utilized.

If a user does not follow one of these two color code standards then the performance and maximum cable distance will be reduced significantly, and may prevent the switch from establishing a link.

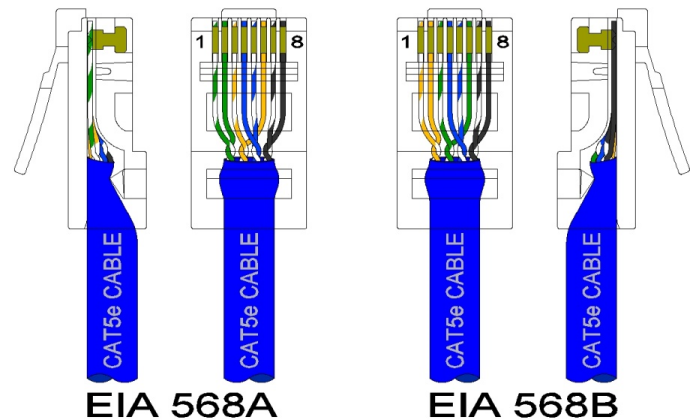

#### Warning / Avertissement

- Creating a network loop without employing a network path protocol such as N-Ring, N-Link, or RSTP is an illegal operation that can create a network storm which will crash the network.
- La création d'un réseau sans boucle employant un chemin réseau protocole tels que N-Ring, N-Link, ou RSTP est une opération illégale que peut créer une tempête du réseau qui va planter le réseau.

### 2.6.2 Connecting 7506 Models

For 10/100/1000 Base-T ports, plug a Category 5E twisted pair cable into the RJ45 connector. Connect the other end to the far end station. Verify that the LNK/ACT LEDs are ON once the connection has been completed. To connect any port to another device (end node, Switch or Repeater), use a standard Category 5E straight through or crossover cable with a minimum length of one meter and a maximum length of 100 meters.

Red Lion recommends using pre-manufactured CAT5E cables to ensure the best performance. If this is not an option and users must terminate their own ends on the CAT5E cables; one of the two color coded standards shown in 2.6.1 should be utilized. If a user does not follow one of these two color code standards then the performance and maximum cable distance will be reduced significantly, and may prevent the switch from establishing a link.

For LC style fiber optic connections, remove the dust cap from the SFP modules and connect the fiber optic cables. The TX port should be connected to the RX port of the far end station. The RX port should be connected to the TX port of the far end station.

### Warning / Avertissement

- Creating a network loop without employing a network path protocol such as N-Ring, N-Link, or RSTP is an illegal operation that can create a network storm which will crash the network.
- La création d'un réseau sans boucle employant un chemin réseau protocole tels que N-Ring, N-Link, ou RSTP est une opération illégale que peut créer une tempête du réseau qui va planter le réseau.

#### 2.6.2.1 Connect the Ethernet Cable

If you are connecting to the unit via the copper port, you will need a straight or crossover cable with two 8-pin RJ45 connectors on each end.

To visually confirm that Ethernet cabling was done properly, check the LED indication on the Ethernet port of the unit. The link LED should be on when the correct cable is used.

**Note:** A shielded cable is required to fully meet EMC standards.

When using shielded cables, it is generally recommended to only connect the shield at one end to prevent ground loops and interference with low level signals (i.e. thermocouples, RTD, etc.). CAT5E cables manufactured to EIA-568A or 568B specifications are required for use with Red Lion series switches.

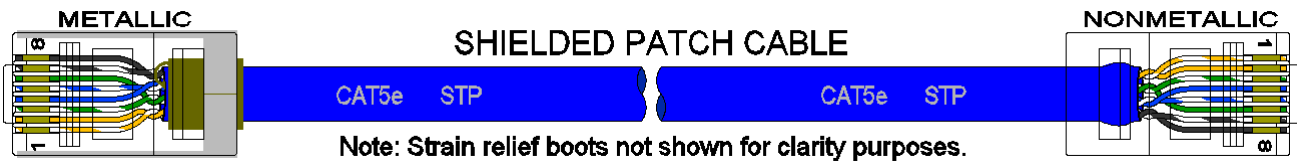

In the event all CAT5E patch cables are short (i.e. All Ethernet devices are located in the same local cabinet and/or referenced to the same earth ground), it is permissible to use fully shielded cables terminated to chassis ground at both ends in systems avoid low level analog signals.

### 2.6.2.2 RJ45 Connector Crimp Specifications

Refer to the illustration below for your CAT5 cable specifications.

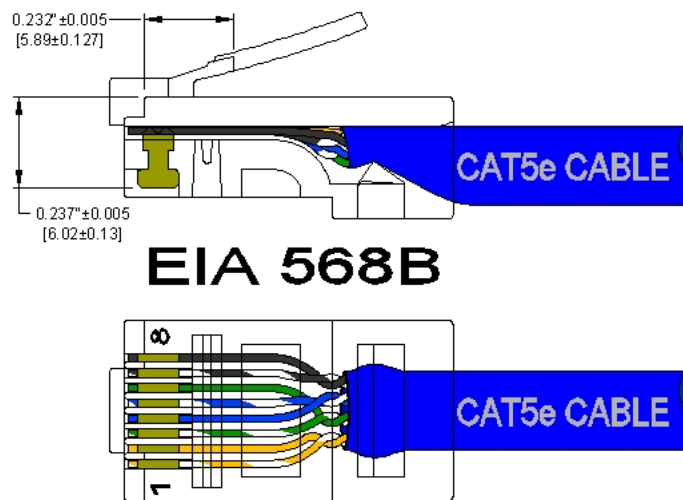

### 2.6.3 Serial Interface (7900)

The 7900 switch models provides an EIA-232 interface accessed via a DB9-pin female connector (labeled 'COM' on the unit). This is used to access the Command Line Interface (CLI). The pin-outs are shown below.

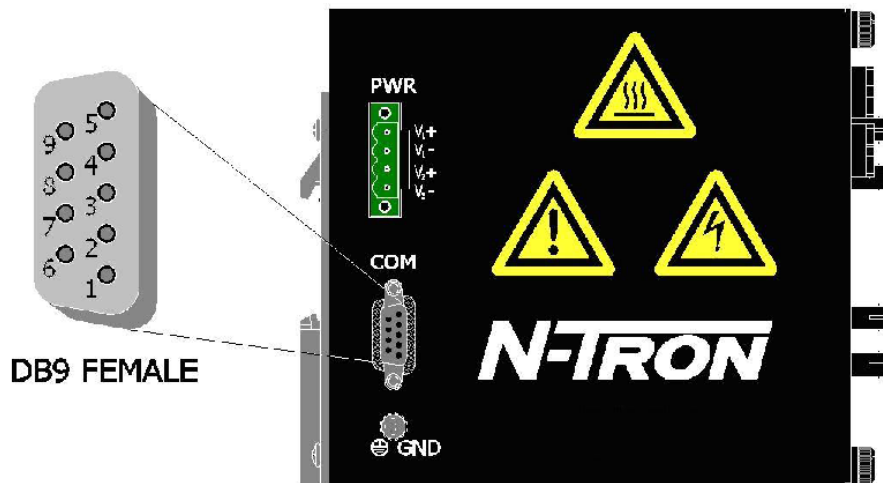

#### 2.6.3.1 Serial Cable Connection (7900)

Connect the serial COM port of your PC and the 7900 switch using a standard straight through serial cable. You will require a cable with a 9-pin or 25-pin sub-D female connector for the PC end, and a 9-pin male sub-D connector for the 7900 switch model end.

The following table shows the pin-out and the connections for both types of cable:

PC Port	25-Pin Female	9-Pin Female	7900 Model 9-Pin Male	
Signal Name	Pin #	Pin #	Pin #	Signal Name
TXD	2	3	3	RXD
RXD	3	2	2	TXD
GND	7	5	5	GND

### 2.6.4 HyperTerminal Terminal Interface

The following configuration should be used in HyperTerminal.

Setting	Value
Port Settings:	115200
Data Bits:	8
Parity:	None
Stop Bits:	1
Flow Control:	None

### 2.6.5 USB Interface

These switches provide a USB interface accessed via the USB connector labeled as “USB” on the unit. This is used to access the Command Line Interpreter (CLI). Each switch USB port location is provided below:

Model	709FX	710FX2	711FX3	712FX4	714FX6	7010TX	7012FX2	7026TX	7506GX2
Location	Bottom	Bottom	Bottom	Bottom	Bottom	Bottom	Bottom	Front	Front

#### 2.6.5.1 USB Cable

Connect the USB port of your PC and the Switch using a standard USB cable. This requires a cable with a Type A connector for the PC end, and a Type B connector for the Switch end.

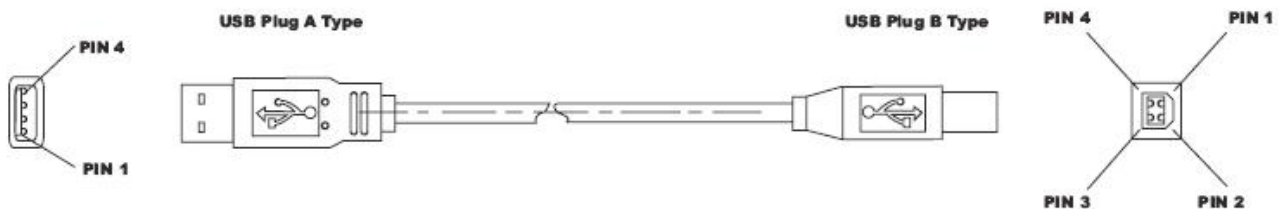

Standard USB cables are available from a variety of suppliers.

## 2.7 Fault Pins

7026TX switches have Fault pins that can be used for an alarm contact. An alarm contact is normally open and the relay closes when a fault condition occurs. These pins can be used to connect an external warning device such as a light in order to provide an external alarm. The conditions for generating a fault condition (closing the relay) can be configured through software. The Fault pins are located on the back and have a current carrying capacity of 1A at 24VDC.

## 2.8 Configuration Devices

The switches have a configuration device insertion point labeled as “NTCD”. This point is used to insert the NTCD-128 configuration device for saving or restoring switch configuration parameters quickly without the need for a computer or software. Each switch NTCD insertion point location is provided below:

Model	709FX	710FX2	711FX3	712FX4	714FX6	7010TX	7012FX2	7026TX	7506GX2	7900
Location	Back	Back	Back	Back	Back	Back	Back	Back	Front	Front

The SD and USB connectors are for temporary connection only.

	<p><b>WARNING:</b> SD and USB are for temporary connection. Do not use, connect, or disconnect unless area is known to be non-hazardous. Connection or disconnection in an explosive atmosphere could result in an explosion.</p> <p><b>AVERTISSEMENT:</b> USB et SD sont de connexion temporaire. Ne pas utiliser, de connecter ou déconnecter sauf si la zone est connue pour être non dangereux. Connexion ou la déconnexion dans une atmosphère explosive pourrait entraîner une explosion.</p>
--	---

### 2.8.1 NTCD-128 SD Card Configuration Device



Ideal for saving or restoring switch configuration parameters quickly without the need for a computer or software. One configuration device per switch is recommended.

## 2.9 Cleaning

Clean only with a damp cloth. Excess moisture or harsh chemicals can cause damage to the unit.

## 2.10 Troubleshooting

Troubleshooting the device is comprised of a few basic steps as provided below. If these do not resolve the issue then contact Red Lion as per the guidance provided in “[Service and Support Information](#)” on page 76.

1. Make sure the  (Power LED) is ON.
2. Make sure you are supplying sufficient current for the version chosen.  
**Note:** The Inrush current will exceed the steady state current by ~ 2X.
3. Verify that Link LEDs are ON for connected ports.
4. Verify cabling used between stations.
5. Verify that cabling is Category 5E or greater for 100Mbit operation.

## 2.11 Servicing (7900)

The 7900 model is a modular design based Gigabit Ethernet Switch with up to four slots for ports and one slot for the CPU module. Please follow the steps below for adding, removing, or swapping modules in the 7900 series switch.

Technicians performing the following steps should wear proper anti-static equipment to protect the circuit boards.

**Warning:** The 7900 model switch is NOT hot swappable. Removing or adding modules while the power is still on can damage the equipment.

### 2.11.1 Adding or Replacing a Module

1. Remove power from the switch.
2. Unscrew the two thumb screws for the filler panel or module that you are replacing.
3. Using both hands pull on both thumb screws to slide the filler panel or module you are replacing.
4. Align the new module such that it slides on the rails and firmly push it into the unit.
5. Screw both thumb screws down till they are finger tight.
6. Reapply the power and configure the slots on the 7900 either through the web management interface or the serial management interface.
7. In order to verify the settings have been configured and saved correctly, you may want to view the Logical View page found in the web browser interface. The dynamic illustration displayed on the Logical View page must match the physical switch configuration respectively in order for the switch to function correctly. If not, please repeat the steps listed above.
8. Validation of the configuration and each physical cable segment may be obtained by using N-View OPC Server software. The software is freely distributed on the Product CD and our web site ([http://www.ntron.com/pdf/setup\\_nviewopc.zip](http://www.ntron.com/pdf/setup_nviewopc.zip)). Once N-View OPC is installed, you should view the Ports Counter page view each connected port. You may find it helpful to copy [Alt]+[PrintScreen] the Port Counter information for each port and paste [Control]+[V] into a Windows document for further review. Please consult your N-View OPC Server manual for additional information.  
**Note:** Modules should be installed in slot order (from left to right). So, in a two slot configuration Slots A and B are populated.
9. Empty slots must be covered with a 9000-FP to meet emission standards.



### 2.11.2 Replacing a CPU Module

1. Remove power from the switch.
2. Unscrew the two thumb screws for the CPU module that you are replacing.
3. Using both hands pull on both thumb screws to slide the CPU module out of the chassis.
4. Align the new CPU Module such that it slides on the rails and firmly push it into the unit.
5. Screw both thumb screws down till they are finger tight.
6. Reapply the power to the switch.

**Note:** All configuration settings are saved to the NVRAM which is stored locally on the CPU Module. If you replace the CPU Module all settings will move with the CPU Module. You can save and download a custom configuration to a TFTP server. The switch's MAC Address and IP Address will also move with the CPU Module.



## Chapter 3 Accessing the Web Software Interface

1. Launch a web browser and enter the IP address of the device into the address bar.  
The DHCP Client is enabled by default with the 192.168.1.201 as the fallback address.

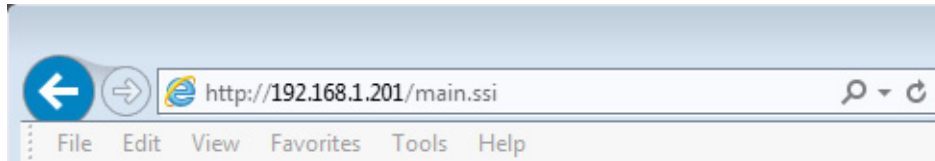

2. The following login screen will appear:

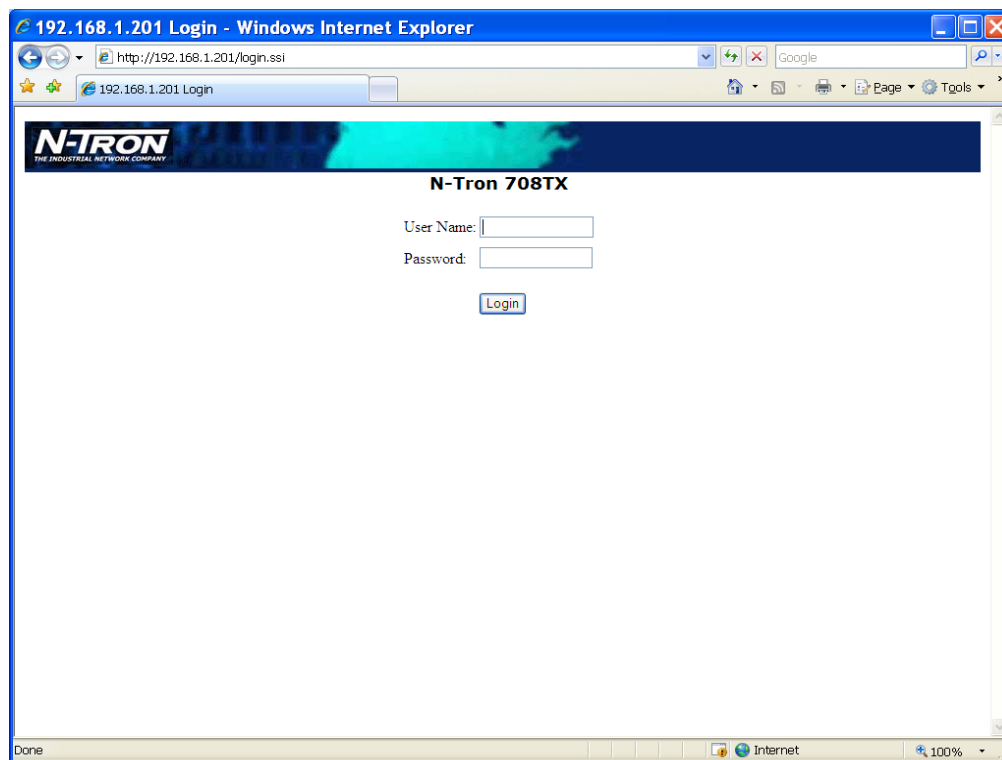

3. For the User Name, enter: **admin** (all lowercase)
4. For the password, enter: **admin** (all lowercase).

**Note:** For security purposes, it is recommended that the password be changed according to your internal policies. Login credentials can be changed on the **User Management** page.

5. Upon successfully logging in, depending on the unit used, a screen similar to the one below will appear:

**N-TRON**  
THE INDUSTRIAL NETWORK COMPANY

- Administration
- DHCP
- LLDP
- Ports
- Statistics
- VLAN
- Bridging
- RSTP
- IGMP
- N-View
- N-Ring
- N-Link
- CIP
- Firmware/Config
- Support
- Rate Limiting
- User Management
- Logical View
- Home
- Config
- Help
- Logout

© 2016 Red Lion Controls, Inc.  
All rights reserved.  
<http://www.redlion.net>  
Logged in as: **admin**

### Product Information

<b>Name</b>	N-TRON 708TX
<b>Software Version</b>	3.9.1
<b>Build Date</b>	Mar 14 2016 at 12:22:02
<b>Boot Loader</b>	BL 2.0.6.1
<b>Copyright</b>	© 2016 Red Lion Controls, Inc.
<b>URL</b>	<a href="http://www.redlion.net">http://www.redlion.net</a>

Please consult the 700/7000 Software Manual (LP0985) for configuration options.



# Service and Support Information

## Service Information

We sincerely hope that you never experience a problem with any of our products. If you do need service, call Red Lion at 1-877-432-9908 for Technical Support. A trained specialist will help you determine the source of the problem. Many problems are easily resolved with a single phone call. If it is necessary to return a unit to us, an RO (Repair Order) can be obtained on the [Red Lion website](#).

Red Lion tracks the flow of returned material with our RO system to ensure speedy service. You must include this RO number on the outside of the box so that your return can be processed immediately.

Be sure to have your original purchase order number and date purchased available.

We suggest that you give us a repair purchase order number in case the repair is not covered under our warranty. You will not be billed if the repair is covered under warranty.

Please supply us with as many details about the problem as you can. The information you supply will be written on the RO form and supplied to the repair department before your unit arrives. This helps us to provide you with the best service, in the fastest manner. Repairs are completed as soon as possible. If you need a quicker turnaround, ship the unit to us by air freight. We give priority service to equipment that arrives by overnight delivery.

We apologize for any inconvenience that the need for repair may cause you. We hope that our rapid service meets your needs. If you have any suggestions to help us improve our service, please give us a call. We appreciate your ideas and will respond to them.

### For Your Convenience:

Please fill in the following and keep this manual with your **RED LION** system for future reference:

P.O. #: \_\_\_\_\_ Date Purchased: \_\_\_\_\_

Purchased From: \_\_\_\_\_ Serial Number: \_\_\_\_\_

MAC Address: \_\_\_\_\_

## Product Support

Inside US: +1 (877) 432-9908

Outside US: +1 (717) 767-6511

Fax: +1 (717) 764-0839

Support: [support.redlion.net](http://support.redlion.net)

Hours: 8:00 am to 6:00 pm EST

Red Lion Controls

20 Willow Springs Circle

York, PA 17406

Website: [www.redlion.net](http://www.redlion.net)



# Limited Warranty

(a) Red Lion Controls Inc., (the “Company”) warrants that all Products shall be free from defects in material and workmanship under normal use for the period of time provided in “Statement of Warranty Periods” (available at [www.redlion.net](http://www.redlion.net)) current at the time of shipment of the Products (the “Warranty Period”). **EXCEPT FOR THE ABOVE-STATED WARRANTY, COMPANY MAKES NO WARRANTY WHATSOEVER WITH RESPECT TO THE PRODUCTS, INCLUDING ANY (A) WARRANTY OF MERCHANTABILITY; (B) WARRANTY OF FITNESS FOR A PARTICULAR PURPOSE; OR (C) WARRANTY AGAINST INFRINGEMENT OF INTELLECTUAL PROPERTY RIGHTS OF A THIRD PARTY; WHETHER EXPRESS OR IMPLIED BY LAW, COURSE OF DEALING, COURSE OF PERFORMANCE, USAGE OF TRADE OR OTHERWISE.** Customer shall be responsible for determining that a Product is suitable for Customer’s use and that such use complies with any applicable local, state or federal law.

(b) The Company shall not be liable for a breach of the warranty set forth in paragraph (a) if (i) the defect is a result of Customer’s failure to store, install, commission or maintain the Product according to specifications; (ii) Customer alters or repairs such Product without the prior written consent of Company.

(c) Subject to paragraph (b), with respect to any such Product during the Warranty Period, Company shall, in its sole discretion, either (i) repair or replace the Product; or (ii) credit or refund the price of Product provided that, if Company so requests, Customer shall, at Company’s expense, return such Product to Company.

**(d) THE REMEDIES SET FORTH IN PARAGRAPH (c) SHALL BE THE CUSTOMER’S SOLE AND EXCLUSIVE REMEDY AND COMPANY’S ENTIRE LIABILITY FOR ANY BREACH OF THE LIMITED WARRANTY SET FORTH IN PARAGRAPH (a).**

