

SECTION A-A

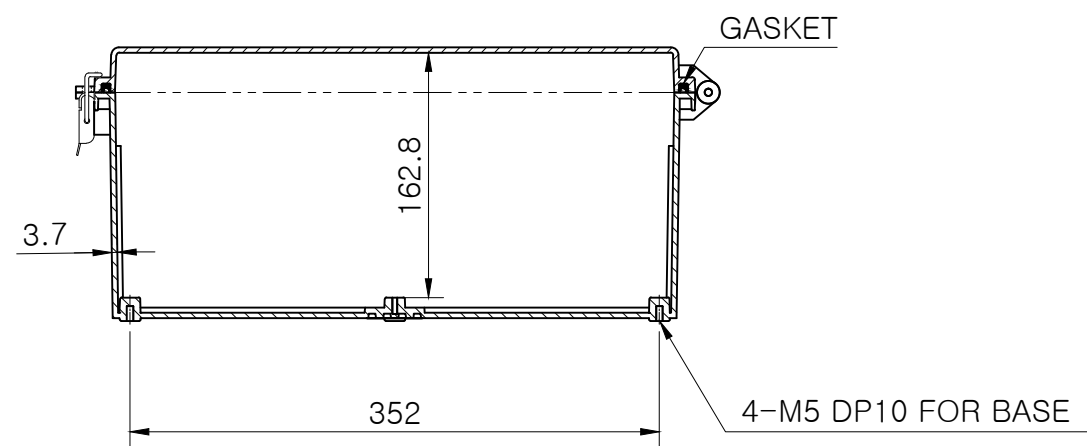
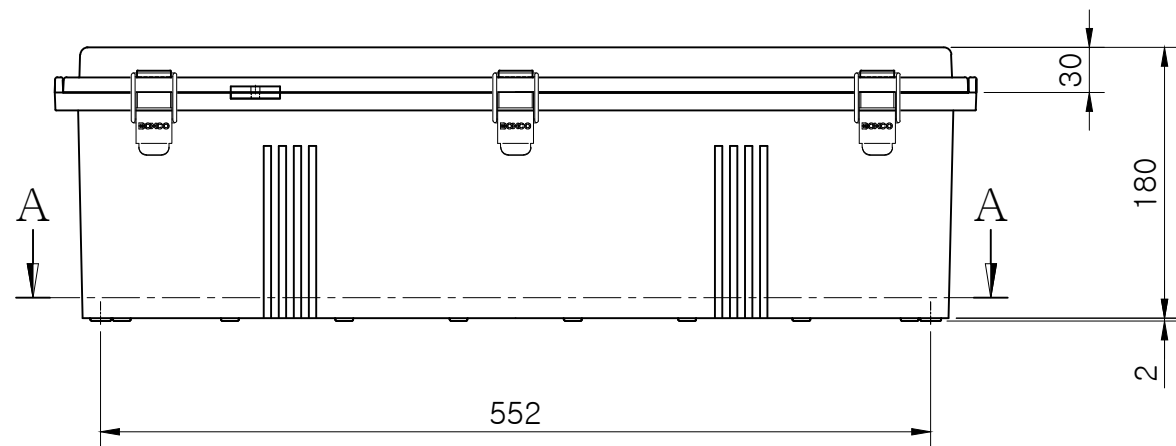

SECTION B-B

Note.

MODEL (모델)	BC-□□P-406018		D R (재도)	JUNG, Y.J.	16.05.06	UNIT (단위)	mm
ASSY (완성 규격)	400 * 602 * 180		C K (검도)	PARK, Y.J.	16.05.06	SCALE (척도)	1:5
DWG NO (도번)	P-406018-03	MATERIAL (재질)	A P (승인)	KIM, D.S.	16.05.07	REV. (개정)	0

